

I|S|C

Solutions in Metal

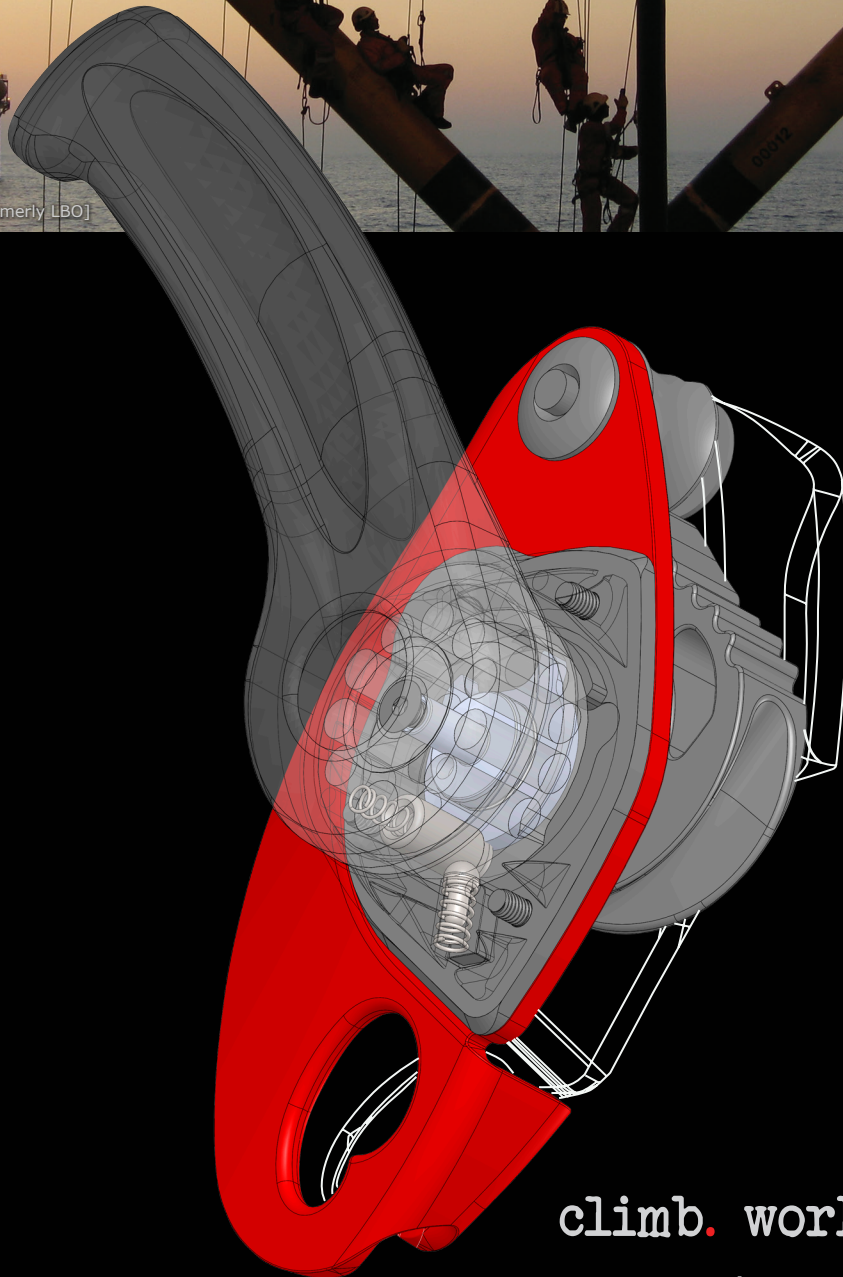

Photo courtesy of Prezioso Linjebygg AS, [formerly LBO]



climb. work. rescue.

2017/2018 Catalogue

climb.
work.
rescue.





Solutions in Metal



Welcome to the ISC product catalogue

ISC Ltd is a world renowned company specialising in the design, development and manufacture of innovative engineered components and other 'Solutions in Metal'. We have been at the forefront of climbing, rigging and rescue product development for more than 20 years and our products are distributed and used in over 30 countries worldwide.

We supply products globally to the 'Working at Height' industry which includes Arborists, Fire & Rescue, Rope Access, and other industrial fall protection users, as well as the Motor Racing, Military and other specialist markets.

ISC products conform to International Standards including CE (PPE Directive 89/686/EEC), ANSI Z359 and NFPA 1983 and are manufactured in accordance with an ISO9001 Quality Assurance system, audited and accredited by SGS.



Herzlich willkommen zum ISC-produkttatalog

ISC ist ein weltweit anerkanntes Unternehmen, das sich auf die Konzeption, Entwicklung und Fertigung von Sicherheitskomponenten und sonstigen 'Lösungen aus Metall' spezialisiert hat. Wir stehen seit über 20 Jahren an der Spitze der Produktentwicklung für Kletter-, Spannsystem- und Rettungslösungen, und unsere Produkte werden in über 30 Ländern vertrieben.

Wir liefern weltweit Produkte für alle Arten von Höhenarbeiten wie Baumpflege, Rettungsdienste, Hochseilparcours, Kletterwände und industrielle Absturzsicherung sowie für Motorsport, militärische Zwecke und sonstige Spezialmärkte.

ISC-Produkte entsprechen internationalen Standards wie CE (PPE Richtlinie 89/686/EWG), ANSI Z359 und NFPA 1983. Sie werden gemäß einem ISO9001-Qualitätssicherungssystem von der SGS hergestellt, geprüft und zugelassen.



Hartelijk welkom in de nieuwe ISC product catalogus

ISC is een wereldwijd gerenommeerde fabrikant gespecialiseerd in het ontwerp, de ontwikkeling en de productie van bijzonder innovatief ontworpen veiligheidsproducten en andere 'oplossingen uit metaal'. Wij begeven ons al ruim 20 jaar in de voorhoede van de product ontwikkeling m.b.t. klimmen, zekeren en redden van hoogte & diepte. Onze producten worden inmiddels in meer dan 30 landen verkocht en gebruikt.

Wij leveren onze unieke producten aan de wereldwijde 'werken op hoogte' sector waaronder; boomverzorging, brandweer & reddingsdiensten, rope access, outdoor & adventure en richting diverse andere industriële sectoren. Daarnaast ontwikkelen en leveren wij producten voor enkele specialistische marktsegmenten zoals de autosport en de militaire & overheidssector.

ISC producten worden conform de geldende internationale wetgeving; PBM richtlijn 89/686/EEG inclusief CE-merk, ANSI normering Z359 en NFPA 1983 geproduceerd, waarbij het interne ISO9001 kwaliteitssysteem (geauditeerd en geaccrediteerd door SGS) ons productieproces borgt.



Bienvenidos al catalogo de productos des ISC

ISC es una empresa reconocida mundialmente que se especializa en el diseño, desarrollo y fabricación de componentes de seguridad crítica y otras 'Soluciones en Metal'. Hemos liderado el desarrollo de productos para el alpinismo, trabajos verticales y de rescate durante más de 20 años y nuestros productos se distribuyen y se usan en más de 30 países en todo el mundo.

Suminramos productos a nivel mundial a la industria de 'Trabajo en Alturas' en la que se incluye la arboricultura, los servicios de emergencia y rescate, trabajos verticales y protección contra caídas así como los sectores militar y del automovilismo entre otros mercados especialistas.

Los productos ISC cumplen con los Estándares Internacionales incluyendo CE (Directiva 89/686/CEE relativa a los Equipos de Protección Personal), la norma ANSI Z359 y la NFPA 1983, y se fabrican de acuerdo con el sistema de calidad ISO9001 auditado y reconocido por la organización SGS.



Bienvenue dans le catalogue de produits ISC

ISC est une entreprise mondialement connue, spécialisée dans la conception, le développement et la fabrication d'éléments d'ingénierie et autres 'Solutions en Métal'. Nous sommes à la pointe du développement de produits d'alpinisme, de levage et de sauvetage depuis plus de 20 ans et nos produits sont distribués et utilisés dans plus de 30 pays à travers le monde.

Nous fournissons des produits à des entreprises pratiquant le travail en hauteur, notamment les arboriculteurs, les services d'urgence, les centres proposant des parcours acrobatiques ou des murs d'escalade protection contre les chutes. Nous fournissons également le secteur des courses automobiles, l'armée et d'autres marchés spécialisés.

Les produits ISC sont conformes aux normes internationales dont les normes CE (directive 89/686/CEE relative aux équipements de protection individuelle), ANSI Z359 et NFPA 1983 et sont fabriqués conformément à un système d'assurance qualité ISO9001 audité et accrédité par SGS.



Benvenuti al catalogo prodotti ISC

ISC è un'azienda di livello mondiale specializzata in progettazione, sviluppo e realizzazione di importanti componenti tecnici di sicurezza e altre 'Soluzioni in Metallo'. Da oltre 20 anni siamo all'avanguardia nello sviluppo di prodotti per l'alpinismo, per i sistemi di paranchi e per le operazioni di salvataggio e i nostri prodotti vengono distribuiti e utilizzati in più di 30 paesi nel mondo.

Forniamo prodotti a livello globale per il settore del lavoro in quota, che include arboricoltura, servizi di emergenza, percorsi elevati, arrampicate e utenti di protezioni anticaduta industriali, oltre a vari mercati specialistici come quello automobilistico o militare.

I prodotti ISC sono conformi agli standard internazionali fra cui CE (Direttiva sui dispositivi di protezione individuale 89/686/CEE), ANSI Z359 e NFPA 1983 e vengono realizzati in conformità al sistema di gestione della qualità ISO9001, verificato e certificato da SGS.



Design, Prototype, Manufacture & Testing



Our philosophy here at ISC is to provide our customers with the best products possible. To achieve this we actively consult with and listen to our customers' ideas, feedback and expectations. This valuable information is then fed in to our new product development process. Feedback about existing products helps to drive our process of continuous product improvement.

We believe that these processes are key to our goal of supplying our customers with products that perform optimally in the demanding environments in which they are used.



Engineering & Design

ISC has a team of experienced engineers who are experts in advanced design and manufacturing processes. Our engineers use the latest state of the art software, hardware and systems through the entire product development cycle. This is all carried out under a single roof at our facility in Bangor, North Wales. We also maintain close ties with a number of Universities giving us access to the latest thinking, materials and technologies, and we encourage and invest in the engineers of the future through work placements and apprenticeships.



Manufacturing Facilities

Our highly skilled manufacturing department is where our innovative product ideas are transformed from raw material to finished goods, within our 25,000ft² facility in North Wales.

Using the latest high speed CNC machines and advanced manufacturing technologies, ISC is ready and able to meet the increasingly complex demands of user groups from around the world for sophisticated yet easy to use products.



Software & Prototyping

Using the latest Solidworks™ 3D Computer Aided Design (CAD) software provides us with a complete design and virtual proving environment. This capability enables our engineers to interact in virtual reality with the products to visualise, test, and optimise the design.

To complement our design abilities we have advanced in house prototyping facilities. These include both manual and CNC machining centres. Our CNC machines are networked to our MasterCam X™ Computer Aided Machining (CAM) software which allows rapid programming of machinery to produce complex 3D surfaces and shapes. The cross section of machinery available allows us to rapidly, accurately and repeatedly reproduce our designs in any metal or plastic material required.



Testing & Quality Control

Product testing, quality inspection and quality control are central to our culture at ISC. Every product sold is individually inspected to ensure that it meets both the relevant national and international standards, as well as our own rigorous standards. At ISC we believe that it is vital that every piece of safety critical equipment has been thoroughly tested and inspected by highly competent people, reassuring the user that each and every component meets the highest standards.

The installation of a new 19m tower at our factory allows us to comprehensively test our products through the development phase to ensure they meet user expectations as well as international standards.

Products



Descenders

12



Back-up & Ropegrab Devices

20



Hand, Chest & Foot Ascenders

22



Anchors & Accessories

24



Climbttech Portable Anchors

27



Deadweight Portable Anchors

31



Tripod Systems

32



Arachnipod Total Edge Management System

34

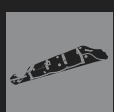

Stretcher & Spinal Board

35

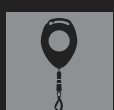

Fall Arrest Blocks (SRLs)

37

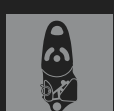

Progress Capture/Rescue Kits

40

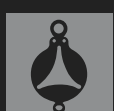

R-ALF™ & LH-ALF™ Locking Pulley Systems

42



ALF™ Climbing Assist Pulley

44



SmartSnap™ Continuous Attachment Device

47



Zip Trolleys

49



Zip/Adventure Park Accessories

51



Pulleys

53



Singing Tree Rope Wrench

58



Karabiners

60

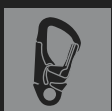

Snaphooks

65



Tactical/Military Products

67



Buckles & Components

68



Quick Release Buckles (QRBs)

70

Industries

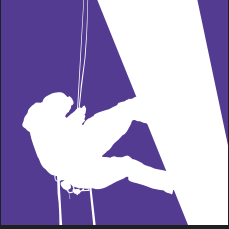

Rope Access

We offer a comprehensive range of products for rope access and rescue. Our engineering expertise is behind some of the most respected products in the industry including the new RAD work positioning device and our comprehensive range of portable anchor devices which are all rated for rescue. But our most recent innovation is the D4™ Work/Rescue Descender which offers a simple, safe and robust solution for rope access users.



Arborist

We offer a comprehensive range of products for Arborists. Our engineering expertise is behind some of the most respected products in the industry including the first ever triple action snaphook, our wide range of heavy duty rigging pulleys is well established as the 'tried, tested and trusted' rigging solution, but our most recent innovation the 'Rope Wrench' offers a revolutionary solution for SRT.

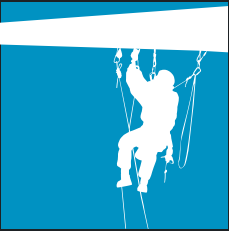

Industrial Height Safety

We offer a comprehensive range of products for the Industrial Work-at-Height and Confined Space sector. Our engineering expertise is behind some of the most respected products in the industry including the R-ALF™ Rescue Auto-Locking Pulley, our wide range of stainless steel karabiners and pulleys is the most comprehensive in the world, and the new range of Merlin fall arrest blocks will offer a competitive alternative for anything bigger than 10m/30ft. But our most recent innovation the D2™ Escape Descender offers a simple and cost-effective solution for the Wind Energy sector.

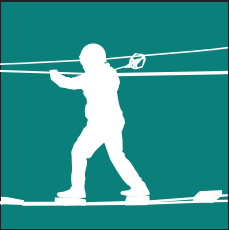

Adventure Park

We offer a comprehensive range of products for the Adventure Park sector. Our engineering expertise is behind some of the most respected products in the industry including the well established ALF™ Climb Assist Pulley, our wide range of Zipline trolleys offers a huge selection of devices and accessories for super-fast high-throughput courses down to smaller clip-on clip-off courses. But our recent innovation the SmartSnap™ offers the most simple and cost effective solution for Individual Safety Systems (Smart Self Belays) Category E.



Edge Management

We offer a comprehensive range of Edge Management solutions. Our engineering expertise is behind some of the most respected products in the industry including the Rescue Tripod and the Deadweight Trolley systems as well as being main European distributor for Arachnipod - the worlds most versatile modular edge management system.

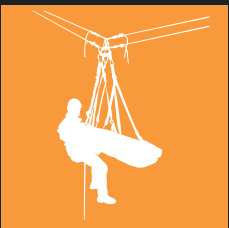

Search & Rescue (SAR)

We offer a comprehensive range of products for the Search & Rescue sector. Our engineering expertise is behind some of the most respected products in the industry including the original Rocker rope grab, our wide range of Prussik pulleys is the most comprehensive anywhere in the world and the Iron Wizard 70kN karabiner is not only the strongest available in the world but our most popular connector for this industry. But our most recent innovations are the D4™ and D5™ Work/Rescue Descenders which offer a simple but versatile and highly robust solution for SAR users.



climb. work. rescue.

I|S|C

Solutions in Metal

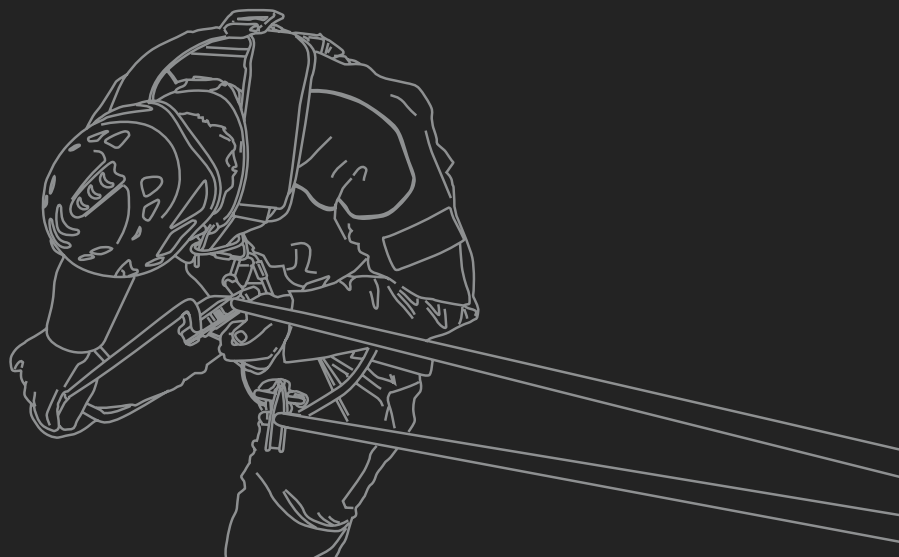
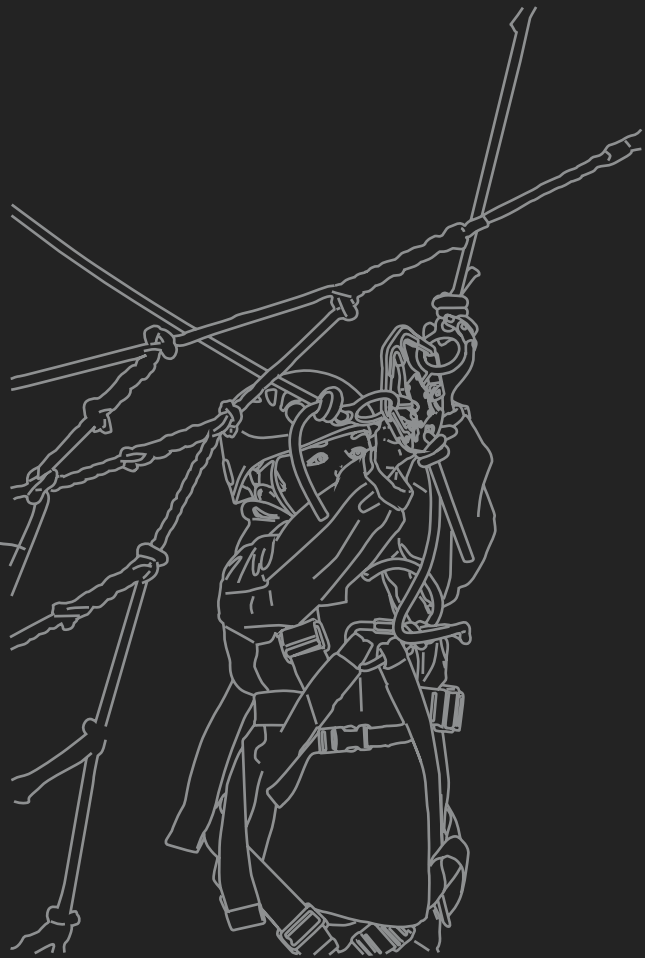
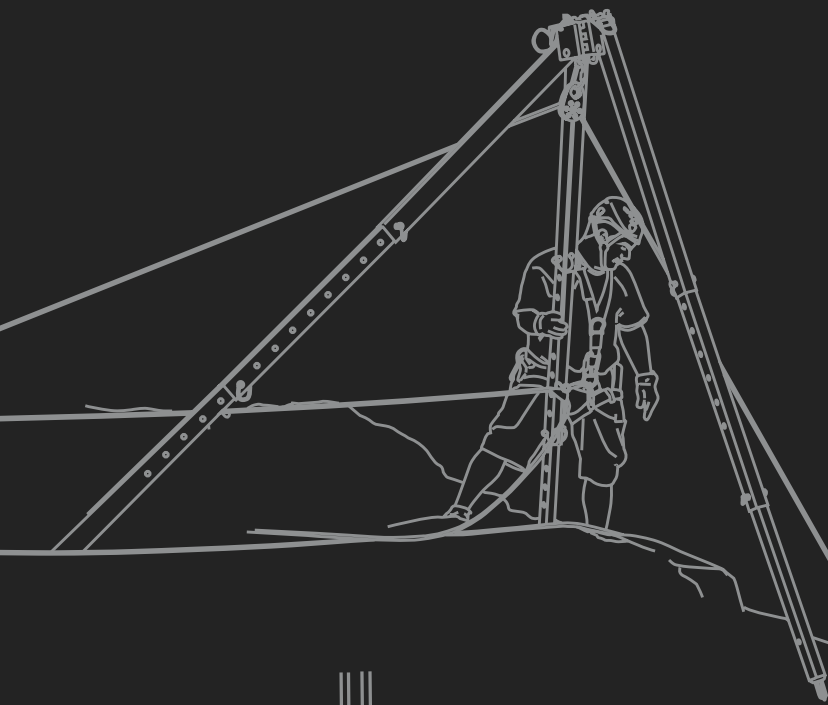

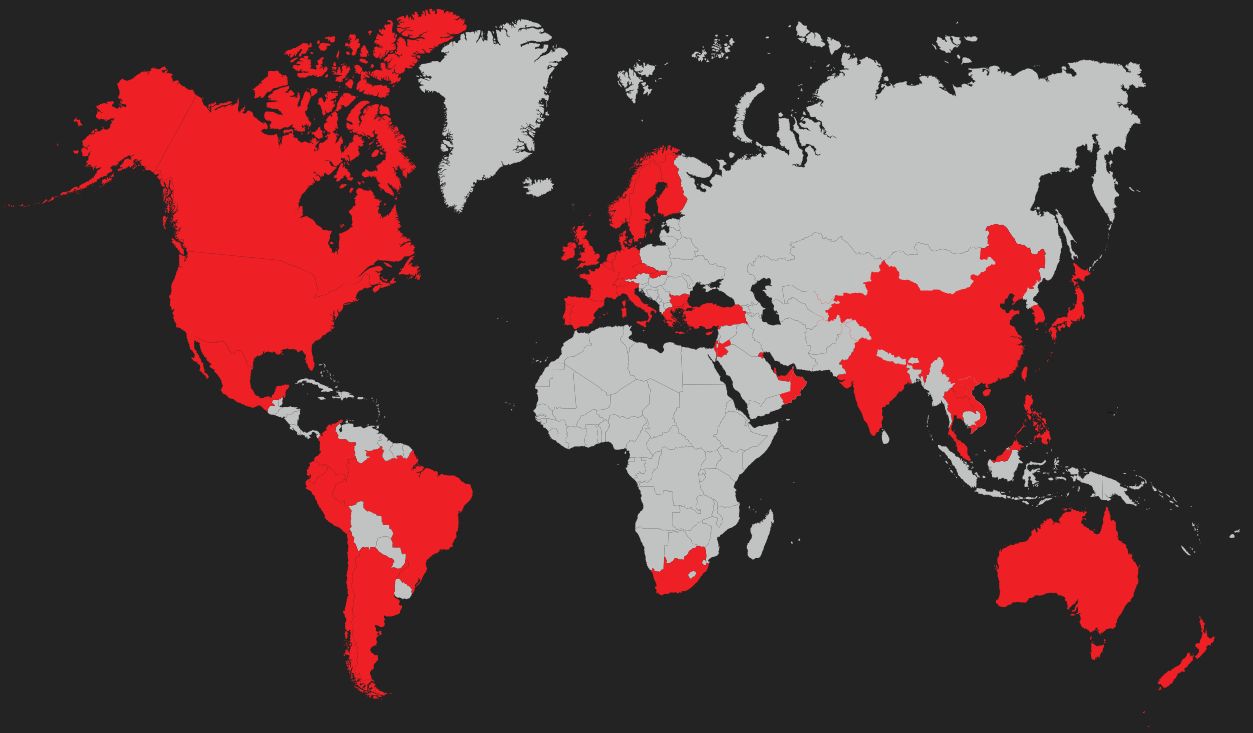

climb. work. rescue.

ISC is a small independently owned company run by enthusiastic people with a passion for innovation and customer service.

Our reputation has been built on listening to customers' needs and then designing and producing robust and remarkable products.

We stick with what we know best - 'Solutions in Metal' - specialising in metal components and systems for Industrial CLIMBING, WORK at height and RESCUE sectors although we have diversified into many other sectors such as motor sport and military.

From small beginnings in 1995, ISC has developed into a mature but fast-reacting business capable of developing truly innovative products for a wide range of markets and users across all continents and the ISC brand is becoming globally accepted as the leading brand for high-quality, high-performance and highly reliable products.



D5™ Work/Rescue Descender

D5™ DESCENDER

The D5™ is a double-stop device with an auto-lock function (which is activated whenever the operator lets go of the handle) and a panic brake which is not overly sensitive in normal use.

NEW!

RP885 D5™ Work/Rescue Descender

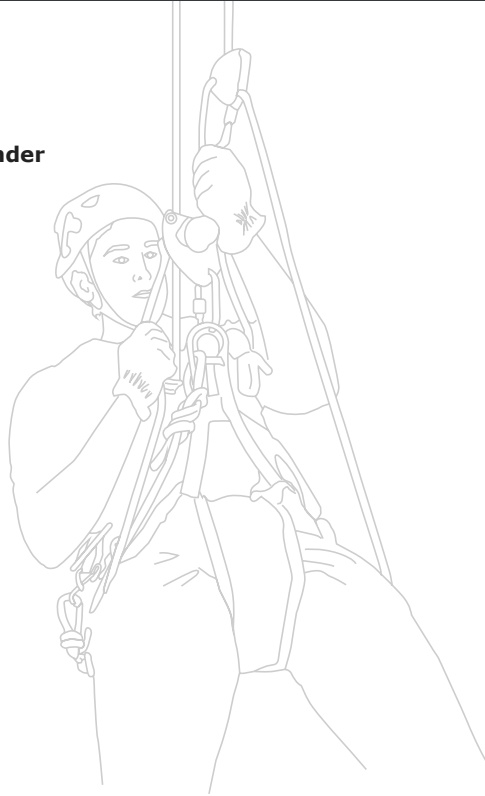

Features & Applications

The D5™ has a rated load of 240kg (550lbs), making it a true Work/Rescue Descender.



The D5™ Descender has a double safety locking mechanism, which means when loaded, the side plates cannot be rotated open due to the positioning of the Karabiner and the push button 'click-lock' safety closure. The D5™ is easy to attach/detach from rope without detaching from the operator's harness, therefore eliminating the risk of accidental dropping of the device.

It is easy to back-feed the rope through the D5™ and therefore it can be used for smooth ascending or for emergency hauling (when used as part of a 2:1 'Z-rig').

The D5™ is compliant with NFPA G and ANSI Z359.4 for the North American Fire/Rescue and Tower Climber markets which typically use 1/2" ropes.

Technical Information

	Weight	Rated Load	Rope Ø
RP885	818g (29oz)	240kg (550lb)	12.7mm (1/2")



The D5™ is suitable for rescue with 12.7-13mm (1/2") Low Stretch Kernmantle ropes. (EN1891).

D5TM

DESCENDER

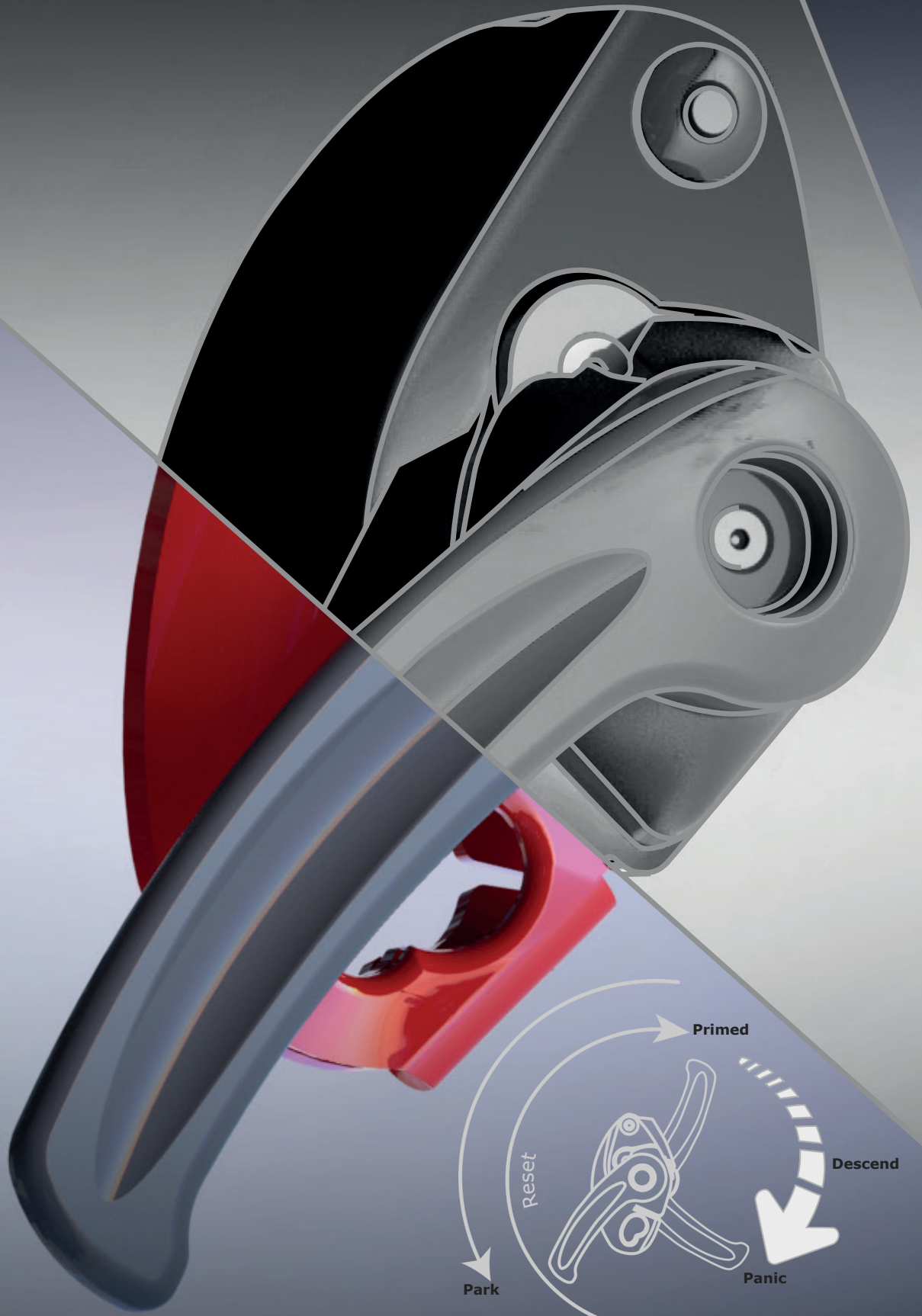

A unique feature of the D series is that the handle rotates fully through 360° and emits audible 'clicks' as an indicator to the user of positive engagement of the mechanism.



Adam Davies

ISC Product Specialist descends the 127m (418ft) National Lift Tower using the D4™ Work/Rescue Descender and RED™ Back-up Device

Location: Northampton (UK).

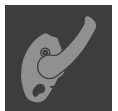

D4™ Work/Rescue Descender



The D4™ is a double-stop device with an auto-lock function (which is activated whenever the operator lets go of the handle) and a panic brake which is not overly sensitive in normal use.

RP880 D4™ Work/Rescue Descender



Features & Applications

The D4™ cam is made from a super hard solid Stainless Steel and is highly wear and corrosion resistant. The D4™ is compliant with CE Standards, NFPA T and ANSI Z359.4 for the worldwide Rope Access and Rescue markets which typically use 10.5mm/11mm ropes.

The D4™ Descender features a unique and innovative progressive cam action, which offers control at slow or fast speeds. The progressive cam works by way of one cam operating inside another cam.

It is also easy to back-feed the rope through the D4™ and therefore it can be used for smooth ascending or for emergency hauling (when used as part of a 2:1 'Z-rig').



Push Button & location hole

The D4™ has a rated load of 240kg (550lbs), making it a true Work/Rescue Descender. Minimum user weight 60kg (132lb).

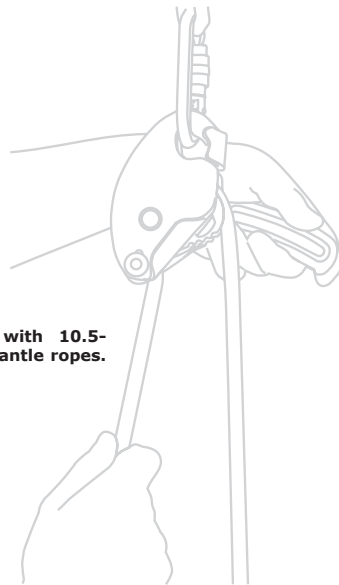

The D4™ is suitable for rescue with 10.5-11.5mm (7/16") Low Stretch Kernmantle ropes. (EN1891).

Technical Information

	Weight	Rated Load	Rope Ø
RP880	678g (24oz)	240kg (550lb)	10.5-11.5mm (7/16")



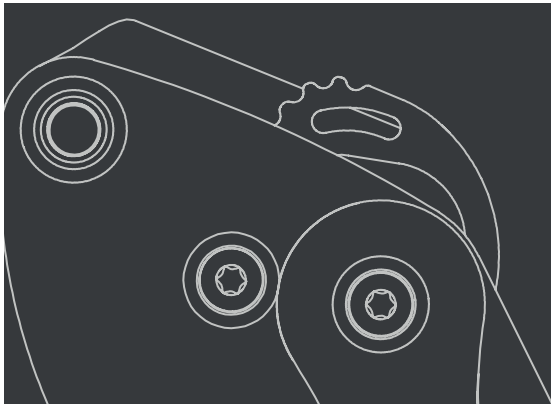
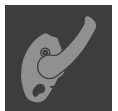

D2™ Escape Descender



The D2™ Escape Descender is a new and innovative 'double-stop' Descender. The 'double-stop' function means that the D2™ Descender has a sweet spot in which the descent speed can easily be controlled. Either side of the sweet spot there is an auto-lock function - when the user lets go of the handle the device automatically stops and when the user pulls the handle too hard the device automatically stops, (often referred to as a 'panic-stop').

KT860 D2™ Escape Descender Kit



EN12841, Meets NFPA

Technora Rope

Aramid fibres (such as Technora), are perfect for use in applications where fire is the main hazard (bail out or evacuation from wind turbines).

Polyester Rope

Standard Polyester ropes are ideal for use in other areas, (such as Linesman self-rescue from pole tops or for escape from towers or elevating work platforms/skylifts).

Features & Applications

Our Engineers developed a new handle operated cam system specifically so that in a panic situation the Descender would actually stop the descent, (rather than just slow it down). The D2™ Descender is the only Micro-Descender in the world to offer this function.

The D2™ can be controlled by pushing in the cam (ideally using the thumb), which allows the user to smoothly feed the rope through the device, without the use of the handle. The cam feed feature is particularly useful in Bail-out Operations.

It is also easy to back-feed the rope through the D2™ and therefore it can be used for smooth ascending or for emergency hauling, (when used as part of a 2:1 'Z-rig').

The Descender is compact and lightweight, allowing it to be carried on the harness at all times - some harness manufactures have integrated it into a harness back-pack so that self-rescue can be made easy.

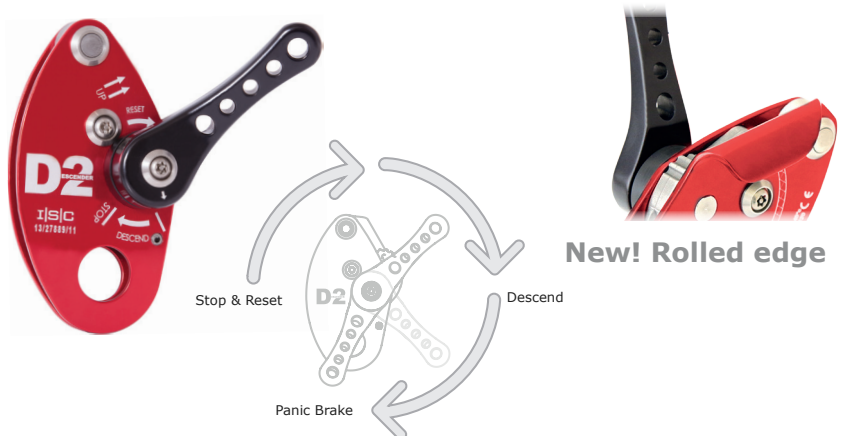

Standard Kits are supplied with a 15m (50ft) working length. Other lengths are available on request. Model shown is KT860A (Polyester rope). Standard kits are assembled with knotted termination. Sewn terminations available on request*.

*Additional fee applies

Technical Information

Rope		Kit Weight	Rated Load	Rope
KT860A	Polyester	493g (17oz)	100kg (220lb)	45g/m (0.5oz/ft)
KT860B	Technora	493g (17oz)	100kg (220lb)	46g/m (0.6oz/ft)



RP810



Features & Applications

The A-B Descender is a 'squeeze style' device, designed for use in Technical Rope Access, Intervention/Special Forces and is rated for two-person rescue loads.

The A-B Descender is fitted with an extended, spring loaded flip down handle which gives extra leverage when a fine degree of descent control is required. The flip down handle is of particular use for extra control of a two-person rescue load.

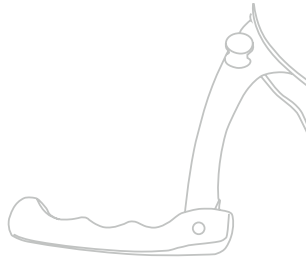

RP815



Features & Applications

The RAD 'Rope Adjustment Device' is a multifunctional device which can be used as part of a work-positioning lanyard (for 10.5 - 12.7mm rope). The RAD can also be used for ascent, descent, work positioning/restraint, belay and progress capture.

The 'squeeze style' device makes smooth adjustment easy, while the spring-loaded flip down handle allows easy use, especially in descent mode.

The RAD can be supplied as an individual device* which can be fitted with rope and a choice of connectors.

The RAD now features a new top bollard, which allows the user the choice of fixing the side plate in place (in line with Lanyard related standards), or removing the captivation screw, allowing the front plate to be swung open. The swinging side plate is particularly useful when the device is in used in descent/ascent function.

* Available outside the EU only
See pages 58-63 for connectors

Squeeze style handle



Technical Information

	Type	Weight	Rope
RP810	A-B Descender	450g (16oz)	10.5-12.7mm (1/2")
RP815	RAD	302g (11oz)	10.5-12.7mm (1/2")



© Photo Courtesy of Aerial View Photography
KT815 RAD Work Positioning





Figure 8 & 9s

Rescue Figure 8 devices have extended side bars to keep the rope in place, preventing the rope from creeping inwards and causing unwanted locking.

The figure 9 device performs in a similar way to the rescue 8, but has the extra benefit of the attachment point being perpendicular to the body. The attachment hole has been twisted through 90 degrees (compared with the standard Figure 8 Device), thus eliminating unwanted twisting between the device and harness connection.

Micro 8

The RP120 Micro 8 was designed specifically to be lightweight & compact, even including a length of rope. It is designed to work on Sterling 6mm TRC rope. The double bar design of the Micro 8 means that the friction can be varied according to the demands of the user.

The Micro 8 is individually CNC machined for strength, with well radiussed edges to reduce rope wear. At 56g (2oz) the RP120 is the lightest Figure 8 in the world.

RP120



RP100



RP110



RP101



RP130



Edge Protection

The ISC Edge Roller is ideal for protecting ropes from wear. Each Edge Roller box has base rollers and side rollers, to protect the rope from edge wear and lateral movement.

Edge Roller boxes are sold separately and boxes can be added or removed to suit the terrain of each application.

ER100



Technical Information

	Type	Weight	MBS	Rope
Figure 8				
RP120	Micro 8	56g (2oz)	25kN (5620lbf)	5-7mm (3/16)
RP110	Standard	112g (4oz)	25kN (5620lbf)	8-13mm (1/2")
RP100	Rescue (Aluminium)	196g (7oz)	35kN (7868lbf)	9-13mm (1/2")
RP101	Rescue (Stainless)	605g (21oz)	80kN (17985lbf)	9-13mm (1/2")
Figure 9				
RP130	Figure 9	200g (7oz)	30kN (6744lbf)	9-13mm (1/2")
Edge Protection				
ER100	Edge Roller (1 Unit)	445g (16oz)	-	8-16mm (5/8")



Ropegrabs & Back-up Devices

ISC standard Ropegrabs are available with fixed or removable (Pip Pin) axles. The Pip Pin axle is quick and easy to fit/release and allows the Ropegrab to be fitted to the rope at any point, without detaching from the user's harness.

ISC Ropegrabs can be used on work positioning lanyard/fliplines as well as part of vertical fall arrest systems.

RED Back-up Device

The RED's cams have a positively locking spring which means that the device is self-parking rather than self-tailing. This is important for Rope Access work techniques as they require the back-up device to be positioned so as to reduce fall factors to a minimum.



The RED is designed for use with an 800mm (31.5") Dynamic Cowstail- shock absorber not required, with one-person load

Popper™ Cord

The Popper™ device is a breakaway release clip, which provides a secondary attachment point for the tow cord. When used during normal positioning activity, this secondary attachment point allows the user to tow the device directly downwards. In a panic situation the popper clip is designed to release under load and mitigate against uncontrolled towing of the device.

RP891 Fixed

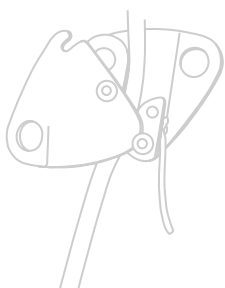

RP892 Popper

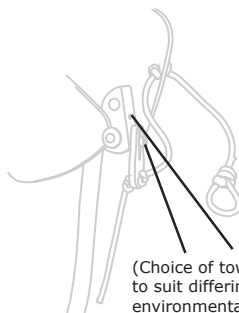

(Choice of towing positions, to suit differing rope & environmental conditions).

Rotational Braking

The RED™ makes use of 'Rotational Braking' which means that the device rotates clockwise creating friction and resistance, which then results in very effective automatic braking in the event of a sudden pull on the cows-tail such as might occur during a main line failure.

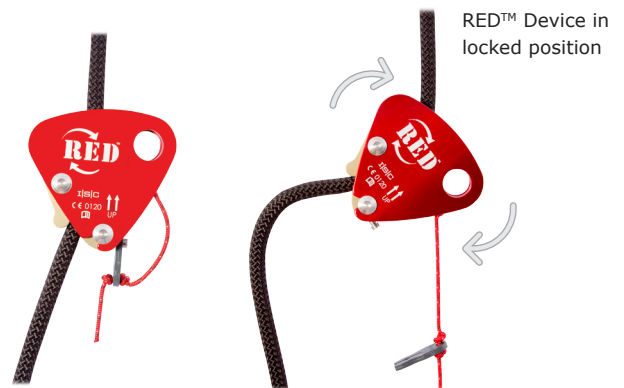

NEW! Stainless Steel Version Available

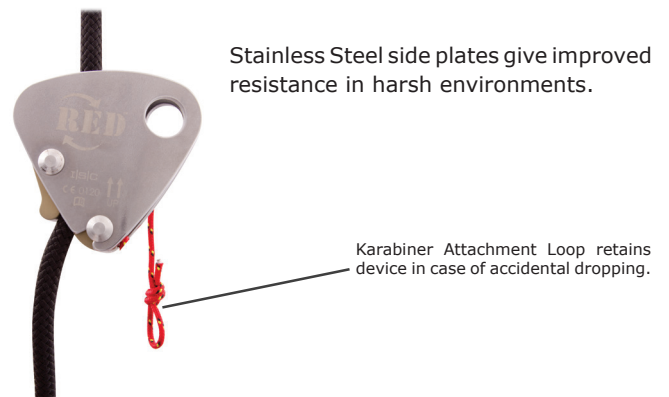

Stainless Steel side plates give improved resistance in harsh environments.

Karabiner Attachment Loop retains device in case of accidental dropping.

Technical Information

	Type	Weight	Rope Ø
RP890	No Cord	221g (8oz)	10.5-11mm (7/16")
RP891	Fixed Cord	222g (8oz)	10.5-11mm (7/16")
RP892	With Popper™	224g (8oz)	10.5-11mm (7/16")
RP892E	With Popper™ (Stainless Steel)	414g (14oz)	10.5-11mm (7/16")

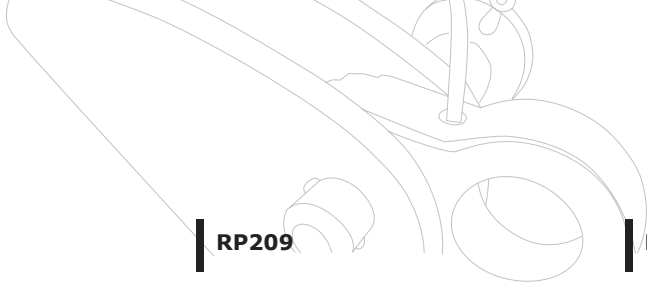

RP203

RP204

RP209

RP205



New Pip-pin retention cord

Rocker™

RP500



© Photo courtesy of Aerial View Photography

Rocker™

The Rocker™ can be fitted to the rope at any point and can be used hands-free as a self-tailing device when travelling up or down the rope. The Rocker is designed for use without a shock-absorber and can be used as a Rope Adjuster or on a work positioning lanyard/Flipline, (In accordance with EN358).

Thumb-catch

Allows the Rocker™ to be 'parked' on the rope at any position, for work positioning or as a mid-line anchor.

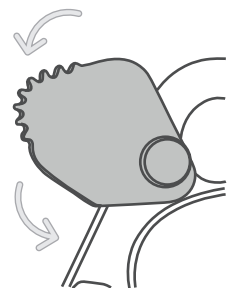

Technical Information

	Type	Weight	Rope Ø
Fixed Axle Ropegrabs			
RP203	Small	177g (6oz)	10.5-13mm (1/2")
RP204	Large	300g (11oz)	14-16mm (9/16-5/8")
Removable Pip Pin Ropegrabs			
RP209	Small	180g (6oz)	10.5-13mm (1/2")
RP205	Large	302g (11oz)	14-16mm (9/16-5/8")
RP500	Rocker™	170g (6oz)	10.5-12.7mm (1/2")



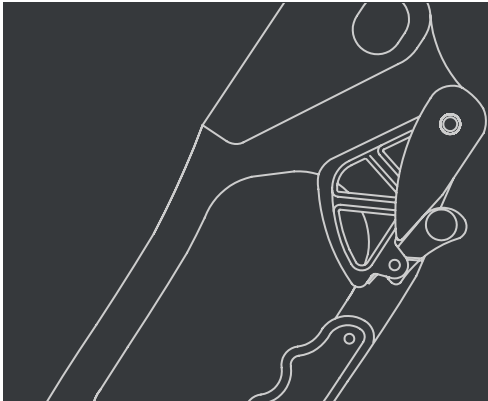

Hand & Chest Ascenders

ISC Hand Ascenders are sleek & ergonomic by design. They are machined from high-strength Aluminium extrusion and are suitable for heavy-duty use.

The ISC Chest Ascender is compact & lightweight and has been designed for use on a full body harness, and therefore it is ideal for use in Rope Access work.



Hand Ascenders

ISC Hand Ascenders are fitted with Stainless Steel cams. All ISC Hand Ascenders have both primary and secondary attachment holes. ISC Ultrasafe Hand Ascenders are fitted with a pin to limit the range movement of the cam in order to prevent the rope from being accidentally pulled out between the cam and the body. ISC Professional and Ultrasafe Hand Ascenders have moulded comfort-grip handles.

Chest Ascender

The cam is spring-loaded and fitted with a catch mechanism, to allow for easy one-handed operation of the device whilst attaching/removing the device to/from the rope.

The Chest Ascender has an increased grip at low load, even on wet/greasy/oily ropes. The spikes are angled downwards, giving maximum grip, whilst allowing the cam to slide easily up the rope.

Foot Adjuster/Foot Loop

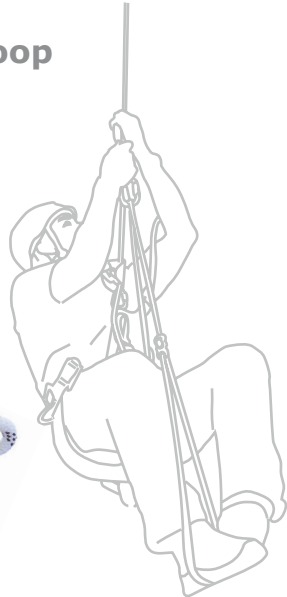

The Rope Adjuster Plate allows the user to quickly and easily adjust the rope as required. The Rope Adjuster Plate offers non-slip rope adjustment.



Suitable for use on 9 - 13mm (5/16-1/2") Rope
Weight: 164g (6oz)

Technical Information

	Type	Weight	Rope Ø
Hand Ascender - Professional			
RP210	Left Handed	364g (13oz)	9-13mm (5/16-1/2")
RP220	Right Handed	364g (13oz)	9-13mm (5/16-1/2")
Hand Ascenders - Ultrasafe			
RP230	Left Handed	367g (13oz)	9-13mm (5/16-1/2")
RP240	Right Handed	367g (13oz)	9-13mm (5/16-1/2")

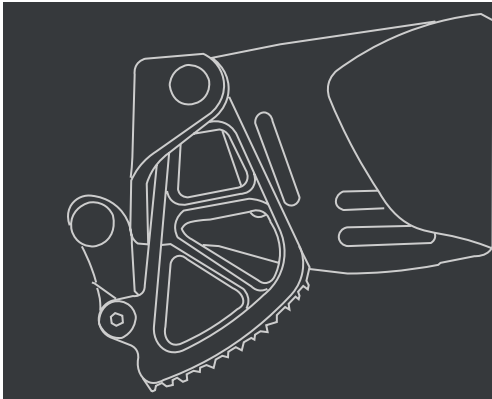

Foot Ascenders

STRYDER™

The ISC STRYDER™ Foot Ascender has been designed following extensive feedback from industry users.

During the development of STRYDER™, durability and functionality were at the top of the priority list. STRYDER™ utilises tried & tested geometry, to provide a smooth upward movement and positive engagement on the rope.

RP227A1 Right



Cam-face & Spring Tension

STRYDER™ utilises the same unique Stainless Steel cam used in our Hand Ascenders. The coned cam-face allows positive engagement on the rope, for a firm and reliable grip, with minimal wear to the sheath.

Great engineering attention was placed on the spring, which has been meticulously designed and trialled to ensure that it offers sufficient tension (so as not to easily 'pop off'), but still allow the device to move freely upwards, without towing the trailing rope.

Foot-operable Cam Lever

The foot-operable cam lever can be used to easily open and close (engage/disengage) the cam. The cam lever can also be hooked over the body of the device (see photo above), to hold the cam in the disengaged position.

Removable Cam Lever: The foot lever bar can be removed by unscrewing an Allen Screw, should the user prefer.

Removing the foot lever bar allows a greater pivot range of the cam. This in turn allows the user to deliberately remove the rope from the device, by using a kick technique, (using only the leg that the device is mounted on).

RP228A1 Left



Mounting Strap

Abrasion Resistant: The STRYDER™ mounting strap and the protective under-foot sleeve are made from a specifically developed webbing, which has undergone extensive abrasion testing and field tests, which have shown superior durability in harsh conditions.

Fully Adjustable: The STRYDER™ is fully adjustable, on both the horizontal and vertical straps, allowing the user to position the device on the boot, according to preference.

Easy to Fit/Remove: The main (horizontal) strap buckle is tightened by firmly pulling down on the free end of the strap; and is released by pulling the toggle upwards, in a one-handed action. The special design of the anti-slip buckle prevents unwanted strap loosening during use.

Creep-free Webbing: The combination of the design of the webbing and the design of the mounting slots and buckles ensure that once correctly adjusted to the desired position, the STRYDER™ should remain in position throughout use.

Technical Information

	Type	MBS	WLL	Rope Ø
Foot Ascender - STRYDER™				
RP227A1	Right	2.5kN (562lbf)	140kg (308lb)	8-13mm (5/16 -1/2")
RP228A1	Left	2.5kN (562lbf)	140kg (308lb)	8-13mm (5/16 -1/2")

NOT for PPE

Individually serial numbered, as standard



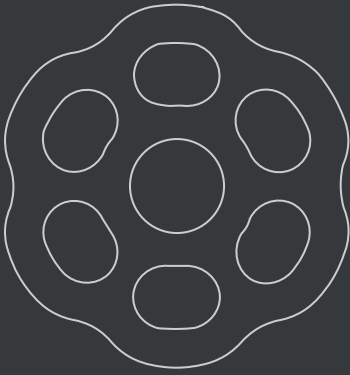

HALO Rigging Plates



Balancing loads is made easier due to the completely symmetrical shape of HALO Plates, hence they are capable of handling a variety of rigging applications.

RP302 Small

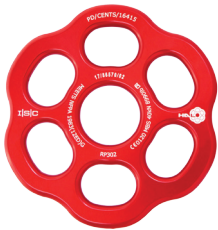

RP303 Medium

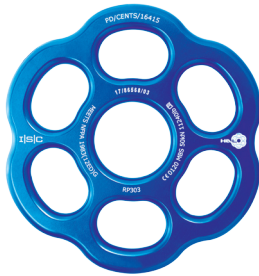

RP304 Large



HALO Rigging Plates form part of a compatible system and were developed to match the ratings on our Karabiners and Prussik pulleys, at 40kN/ (8992lbf), 50kN (11,240lbf) and 70kN (15,736lbf).

If compatible components are used in a system it takes away some of the guesswork involved with deciding which is the 'weak link'.

Each plate is manufactured from aerospace grade Aluminium and feature uniquely shaped apertures which allow for loading with multiple Karabiners simultaneously. CNC machined radiused edges make the apertures rope and webbing friendly.



Technical Information

	Type	Diameter	Weight	MBS
Rigging Plates				
RP302	Small	115mm (4 1/2")	118g (4oz)	40kN (8992lbf)
RP303	Medium	144mm (5 10/16")	221g (8oz)	50kN (11240lbf)
RP304	Large	165mm (6 1/2")	377g (13oz)	70kN (15736lbf)



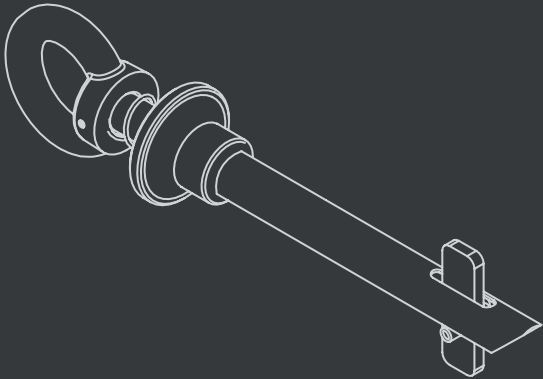

Anchors & Accessories

Girder Grip & Wire Anchor Stropps are made from high strength materials & can be used in vertical or horizontal plane. Girder/Concrete Anchors & Stropps are Approved to CE EN 795.

ISC Rigging Plates are made from high strength Aluminium and have 20mm (3/4") holes, to allow Karabiners to be fully rotated.

GG101

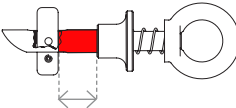
Working Length: 43mm (1 11/16")

GG201

Working Length: 335mm (13 3/16")

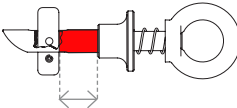
GG301

Working Length: 100mm (4")

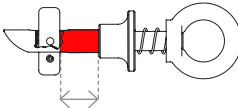
WSX00 Range

Stainless Steel version now available

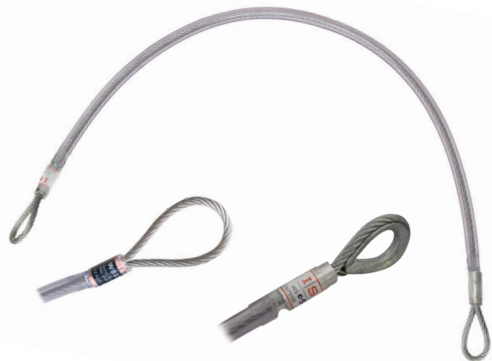

ISC Girder & Concrete Anchors

ISC Girder & Concrete Anchors are a quick and easy portable anchorage solution which can be used in the vertical or horizontal plane. These anchors are operated by using two fingers to pull back the red collar. This action retracts the retention bar, allowing the device to be inserted in to the anchor hole. Once the device is in position, the red collar can be released, causing the retention bar to engage, fixing the device in position.

ISC Wire Stropps

ISC Wire Stropps are available with 7mm Galvanised Steel or Stainless Steel wire and with a choice of thimble (rigid) eye, or soft eye loops. ISC Stropps are fitted with a protective PVC cover. Stropps are available in a range of standard lengths (at 0.5m increments), with bespoke lengths also available on request.

RP300



RP310



RP320



Technical Information

	Type	Weight	MBS
Girder/Concrete Anchors - EN795			
GG101	Small (Girder Grip)	565g (20oz)	28kN (6294lbf)
GG201	Large (Concrete Anchor)	1185g (42oz)	28kN (6294lbf)
GG301	Medium (Pre-cast Anchor)	680g (24oz)	28kN (6294lbf)
Wire Stropps - EN795			
WS100	100cm (39")	502g (18oz)	25kN (5620lbf)
WS150	150cm (59")	780g (28oz)	25kN (5620lbf)
WS200	200cm (78")	998g (35oz)	25kN (5620lbf)
Rigging Plates			
RP300	Small	93g (3oz)	36kN (8093lbf)
RP310	Medium	220g (8oz)	40kN (8992lbf)
RP320	Large	442g (16oz)	45kN (10116lbf)



Photo Courtesy of Canadian Rope Access

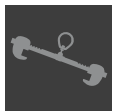



ClimbTech™ Portable Anchors

Developed and manufactured in the USA the full range of Climbtch anchors is available through ISC, as their primary European distributor.

CT100



Beam Trolley

The ClimbTech™ Beam Trolley is a mobile anchor point, for use on structural beams. The device is fitted with toggle plates, which allow for simple adjustment of the rollers when installing/uninstalling the device. The Beam Trolley is ideal for use as an anchor connection for fall arrest systems, (not suitable for material handling). No surface alteration (i.e. drilling), is required in order to use the Beam Trolley.

Technical Information

	Weight	MBS	WLL
CT100	3.5kg (8lb)	22kN (5000lbf)	140kg (310lb)

Beam Sliders

CT101.2



88mm - 355mm (3½" - 14" range)

BANTAM Slider

The ClimbTech BANTAM Beamer Beam Slider is a removable and reusable sliding I-Beam Anchor, which is easy to place, adjust and move- without the need for tools. The Beam anchor is designed to easily slide along the beam, trailing the worker, overhead or at foot level.

The Paw inserts are made from a self-lubricating Silicone Bronze Alloy, which is designed not to bind on the beam. The BANTAM is fitted with a swivel eye, which rotates through 360 degrees.

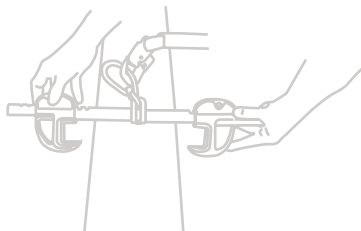

CT110



305mm - 762mm (12" - 30" range)

Beam Slider

The ClimbTech™ I-Beam Slider and Super Beam Sliders are lightweight, reusable anchor clamps which can be attached to a range of beam widths. The Beam Sliders are quick & easy to fit/adjust and eliminate the need for surface alteration (i.e. drilling). Once mounted, the Beam Sliders slide freely and easily along the beam in either direction.

Beam sliders are suitable for use in Rope Access and Suspension Applications and are suitable for rescue loads.

Technical Information

	Weight	MBS	WLL
CT101.2	1.6kg (3.5lb)	22kN (5000lbf)	140kg (310lb)
CT110	3.5kg (8lb)	22kN (5000lbf)	140kg (310lb)



Vertical/Fixed Beam Clamp

NEW!

CT113

The ClimbTech™ Vertical Beam Clamp is quick and easy to fit, remove and adjust. Designed to clamp onto horizontal or vertical I-Beams, to create a fixed anchor point.



102mm - 355mm (4" - 14") range
Flange thickness:
(7-31mm (1/4" - 1 1/4"))

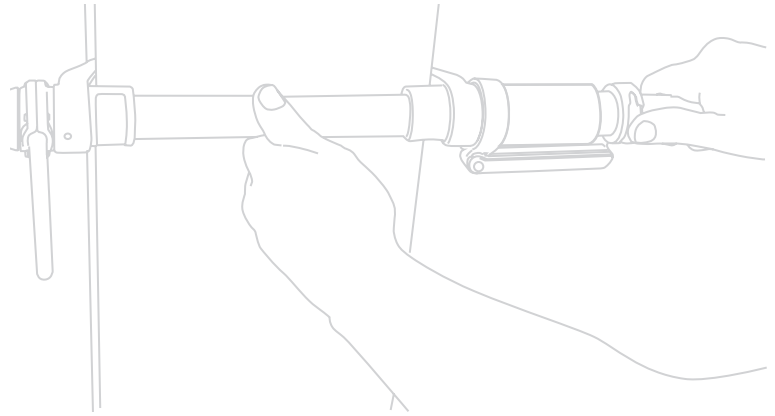
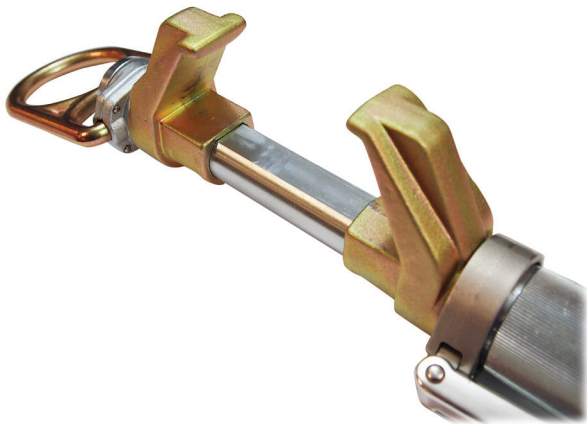

Technical Information

	Weight	MBS	WLL
CT113	3kg (7lb)	22kN (5000lbf)	454kg (1000lb)

Concrete/Steel Swivel Anchor

The ClimbTech™ Concrete MEGA Swivels rotates through 360° and the D ring pivots through 180°, for maximum versatility. The Swivel Anchor is ideal for permanent or portable use for horizontal lifeline systems, tie back, staging and rigging.

The CT105 Concrete Anchor requires a minimum hole depth of 19mm (3/4").

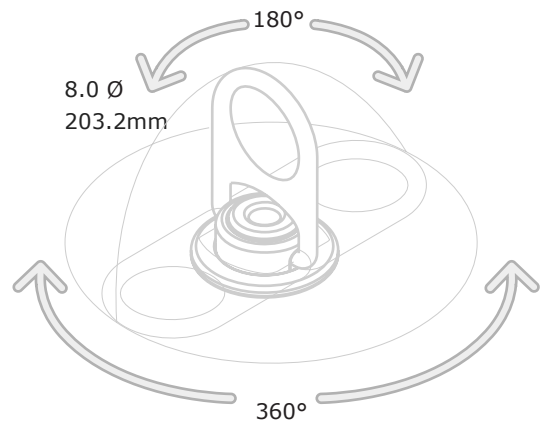

CT105 (Concrete)

CT106 (Steel)

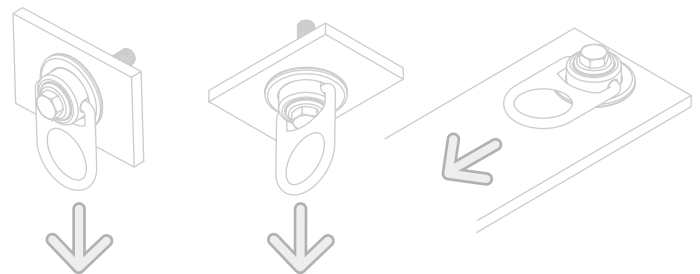

Technical Information

	Weight	MBS	WLL
CT105	917g (32oz)	44kN (10,000lbf)	181kg (400lb)
CT106	847g (30oz)	44kN (10,000lbf)	181kg (400lb)

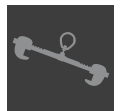

CT102



Removable Concrete Anchors

ClimbTech™ Concrete Anchors are portable, reusable devices which can be used in vertical, horizontal or overhead concrete substrate surfaces. Once a suitable hole has been drilled, the anchors can be inserted and removed as required. These anchors are available in two sizes/ratings and are suitable for fall protection applications.

Technical Information

	Weight	MBS	WLL
CT102	221g (8oz)	22kN (5000lbf)	140kg (310lb)
CT103	222g (8oz)	44kN (10000lbf)	140kg (310lb)

CT103

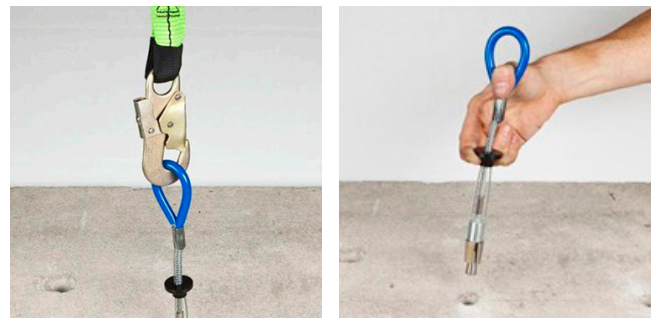

CT104



Toggle Lok Anchors

The ClimbTech™ Toggle Lok Anchor is a portable, reusable device which can be used as part of a flexible horizontal life line system (for up to two users), or as a direct anchorage connection (single user). The Toggle Lok can be used in precast concrete and on steel flanges and can be placed in horizontal, vertical, and overhead surfaces.

This Anchor should be placed in to a 20mm (3/4") diameter hole.



Technical Information

	Weight	MBS	WLL
CT104	181g (6oz)	22kN (5000lbf)	181kg (400lb)





Deadweight Trolley

The Deadweight Trolley is a Portable Anchor Device for use behind Structural Handrails, Balustrades and Parapet Walls. The Deadweight Trolley is quick and easy to set up, store and transport and is ideal for use where space is limited.



DW100.2

Rated use: 2 man

CE Certified: EN795:2012 Type E
Complies with PD CEN/TS 16415:2013 recommendations for Anchor Devices for use by more than one person simultaneously.

15kN Static tested in accordance with IRATA, SPRAT and other industry leading ICOP guidance

Minimum Upstand Required: 600mm (24")

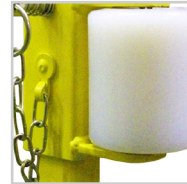
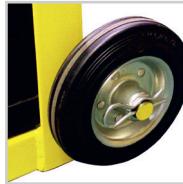

A-Frame

The A-Frame Anchor is ideal for use on flat roof surfaces. The A-Frame can be moved sideways as required, therefore saving time by reducing the need for re-rigging. The A-Frame has locking wheels, to prevent unwanted movement. The A-Frame can easily be disassembled in to 6 pieces (plus 12 weights), for easy transport and storage.



DW200.2

Rated use: 2 man

CE Certified: EN795:2012 Type E
Complies with PD CEN/TS 16415:2013 recommendations for Anchor Devices for use by more than one person simultaneously.

15kN Static tested in accordance with IRATA, SPRAT and other industry leading ICOP guidance

Minimum Upstand Required: 300mm (12")

Maximum Upstand Height: 1500mm (59")

Maximum Parapet Width: 690mm (27")



Technical Information

	Height	Length	Width	No. of Component Parts	Max Component Weight	Total Weight	Max Rated Load
DW100.2	141cm (55 1/2")	57cm (22 1/2")	54cm (21 1/4")	7 (including weights)	25kg (55lb)	178kg (392lb)	200kg (440lb)
DW200.2	218cm (85")	267cm (105")	147cm (58")	18 (including weights)	25kg (55lb)	396kg (873lb)	200kg (440lb)



Tripods & Accessories

The ISC rescue-rated tripod is a high performance, highly robust tripod designed for the harshest working environments. Its key feature is the WLL of 350kg (based on a safety factor of 10:1), allowing it to be safely used for rescue purposes (two-person loads). ISC Tripods feature twin anchor points for attaching a variety of fall arrest and rescue systems.

Tripod

ISC Tripod Heads are manufactured from Cast Aluminium for strength and durability. The standard version (TP143) is fitted with two pulley wheels, with removable captive pins to keep the rope/wire line in place on the pulley wheel. The standard Tripod also has two swivel-eye anchor points. The Tripod legs are adjusted with R-Clips, up to a maximum overall height of 255cm (approximately 100"). ISC Tripods are ideal for work and rescue in confined spaces.

Extensive testing of our Tripods without a foot retention strap has confirmed that our Tripods meet/exceed the strength requirements of the standard, without the need to tether the feet. Our Tripod can therefore be supplied and used without a foot retention strap, meaning that the trip hazard around the Tripod is greatly reduced.

Attachment Bracket

A hard wearing Tripod Bracket, for use with the ISC Tripod, UB171 Fall Arrest Block or Winch system. The GRB150 anti-slip bracket is quick and easy to fit, with a hinged lid and screw design.

We manufacture brackets to fit a range of Tripods - please contact our Customer Service Team for further information.

Winch

The Rescue Winch is designed for use in lifting & lowering applications. We manufacture a range of Tripod attachment brackets. The RW020 Rescue Winch has a working length of 20m (65ft) and should always be used with a secondary back-up system.

The Rescue Winch is fitted with a Steel Swivel eye, double action Snaphook as standard.

GRB150S2

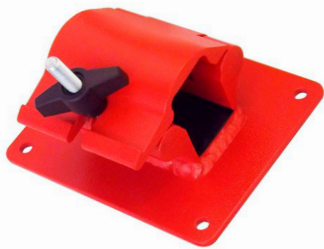

RW020



Fall Arrest Blocks

The UB171 Fall Arrest Block has a cast Aluminium housing, making it suitable for heavy-duty use, even in harsh environmental conditions. The UB171 is fitted with a retrieval winch which can be easily engaged in emergency situations.

The block is fitted with a Swivel-eye Karabiner, which also has a load-indicator. In the event of a fall, the swivel eye will pull out a short way, exposing a red collar.

UB171 15m (50ft)



Weight: 11.4kg (25lb)
WLL: 136kg (300lb)
Fall Indicator: As standard
Gate Type: Twistlock
Wire Diameter: 5mm (3/16")



TP143



Basic Dimensions

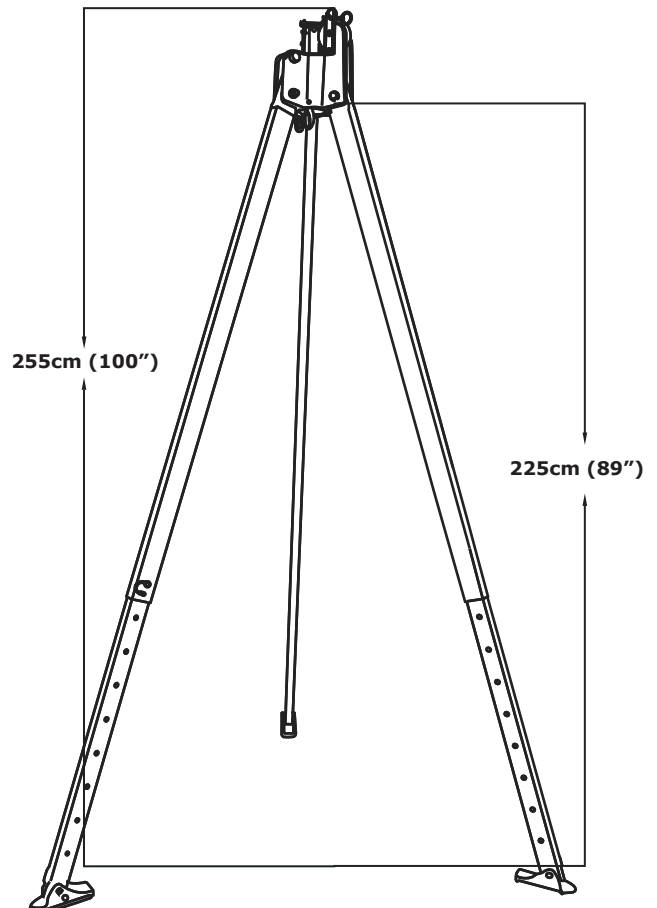
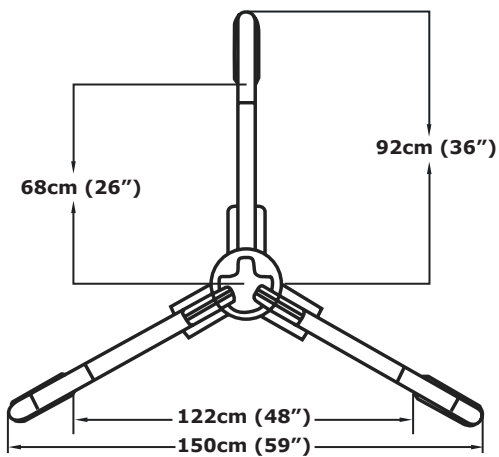

Weight: 22kg (49lb)
WLL: 350kg (771lb)
Max Height: 255cm (9ft)

Accessories sold separately



arachnipod

The World's most versatile Modular Total Edge Management System

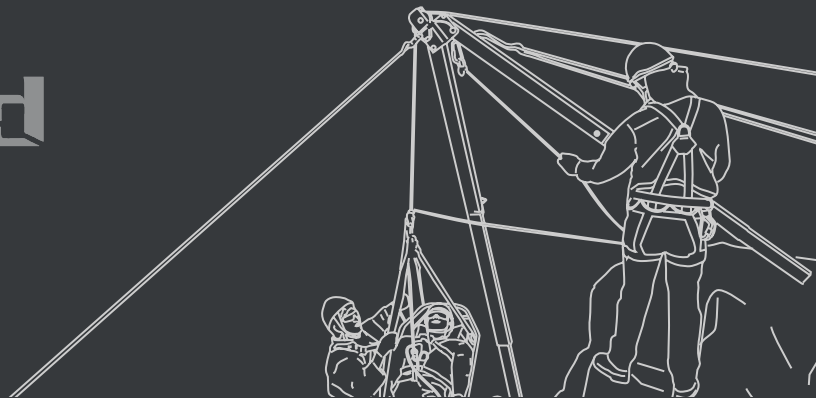

Gin/Mono Pole



A-Frame



Side A-Frame



Handrail Recovery



Tripod/Quadpod



Bridge

The Arachnipod Total Edge Management System is an innovative design that captures multi-functional capabilities. Simplicity and robust engineering provide the world's most versatile modular, total edge management system. Components can be added or removed to achieve any of the 8 possible configurations.

The Arachnipod, in its basic form, is a Tripod. It consists of three basic telescoping legs, each pivotally connected to an Anodised Head. The Head is produced from Aluminium extrusion with cutouts down each side. These cutouts allow two or more heads to connect together with a Quick-link Pin (similar to a hinge), which allows quick and simple addition or removal of legs, or bridge beam, to create different configurations.

Each head has a D shaped shackle for guying to stabilise the structure. The pulley leg has an inbuilt Pulley, which is mounted on two Stainless Steel Roller Bearings. The Pulley is Stainless Steel and has two grooves - one to take up to 13mm (1/2") rope and another to take up to 8mm (5/16") wire cable. Stainless detent pins prevent the rope or wire from coming out of the grooves.

Distributed by ISC

Please contact us for further information





SL 100 Slix™ Stretcher

The Slix™ Stretcher provides a robust, compact & lightweight rescue solution across rough terrain or in an industrial environment. Flexible, smoothly finished material allows easy slide manoeuvring of the Stretcher. The Slix™ can be rolled up widthways or lengthways, for ease of transport and storage.

The webbing straps do not pass underneath the stretcher body, keeping them safe from abrasive damage as the Stretcher is dragged over surfaces. The Slix™ Stretcher is fitted with several durable web handles.

The lifting strap anchors are positioned for optimal balance and ease of use as the stretcher is hauled in a horizontal or vertical orientation. Under tension, the lifting straps cause the stretcher to mould around the casualty, for additional support & security.



Total Kit Weight (packed) 12kg (27lb)

Technical Information

		Width	Length	Max User Weight
SL100	Stretcher	92cm (36")	230cm (91")	400kg (881lb)



SL50 Slix Spinal Splint Board

The Spinal Splint is designed to be used with the Slix Stretcher, for additional support and protection of the casualty. The Spinal Splint lumbar pad is adjustable, which combined with the new design crutch straps, allows one size fits all, with greater casualty comfort and security. The head pocket & back board are well padded and the sides and top of the head pocket are also stiffened for extra protection. Rotating/swivel Velcro™ head closures ensure security and versatility. The Spinal Split it fitted with colour coded crutch straps and three cross-body straps - all of which are rated at 400kg (881lb).

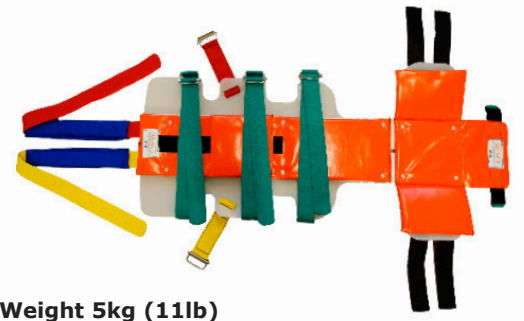

MERLIN™

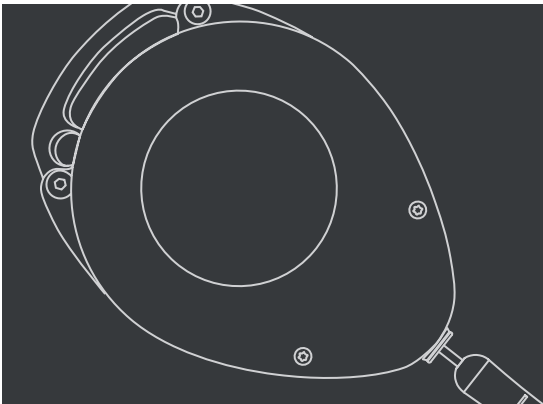
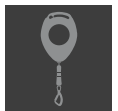

Fall Arrest Blocks (SRLs)

ISC Fall Arrest Blocks are fitted with Fall Indicating, Swivel Eye connectors as standard. All ISC Blocks have solid Aluminium housings, proven to last in all sorts of environments, from rental to off-shore. The internal mechanisms are simple, making them easily servicable.

UB100 (10m/32ft)

Weight: 4.2kg (8.8lb)
WLL: 140kg (310lb)



Merlin Fall Arrest Blocks

The NEW Merlin Wire Fall Arrest Blocks are lightweight Blocks with durable, Cast Aluminium housings. The new design features an offset attachment hole, designed to position the block in order to keep the working line free from excessive bend, as it exits the block. As standard, Merlin blocks are fitted with a CE and ANSI rated steel swivel-eye double-action snaphook with built-in fall indicator, but other connectors including stainless steel models are available on request.

UB100/250/251 Blocks are available with Stainless Steel cable.

UB250 (25m/82ft)



Weight: 12kg (423oz)
WLL: 140kg (310lb)

UB251 (25m/82ft)



Weight: 12.5kg (441oz)
WLL: 140kg (310lb)





Fall Arrest Blocks (SRLs)...continued



UB033 3.3m (11ft)



Choice of Hook Available

Weight: 1kg (2lb)*
WLL: 136kg (300lb)

UB066 6.6m (22ft)



Choice of Hook Available

Weight: 2kg (5lb)*
WLL: 136kg (300lb)

See pages 58-63 for Karabiners & Snaphooks

UB050 5m (16ft)



Weight: 3kg (7lb)
WLL: 136kg (300lb)
Fall Indicator: As standard

UB051 5m (16ft)



Weight: 3kg (7lb)
WLL: 136kg (300lb)
Fall Indicator: As standard

Options +



Fall Indicators

All Fall Arrest Blocks should be serviced following a fall. ISC Fall Arrest Blocks* are fitted with Karabiners, which indicates when a fall has taken place.

*Choice of hook available on Merlin UB033 & UB066 Webbing Fall Arrest Blocks.

*Weight of block excludes hook



UB170 15m (50ft)



Weight: 9.5kg (21lb)
WLL: 136kg (300lb)
Fall Indicator: As standard

UB171 15m (50ft)



Fitted with emergency retrieval winch

Weight: 11.4kg (25lb)
WLL: 136kg (300lb)
Fall Indicator: As standard



Standards

ISC Fall Arrest Blocks conform to CE and ANSI standards.



Service & Repair

Become an Approved ISC Block Service & Repair Agent...

We offer Fall Arrest Service Training courses, which take place at the ISC Factory in North Wales, or can be arranged at your own premises*. For further information the range of courses, please contact the ISC Customer Service Team.

*Fees Apply



Photo courtesy of Safe Site Netherlands

Technical Information

Name	Height	Width
UB033 Merlin Webbing 3.3m (11ft)	150mm (5 7/8")	110mm (4 3/8")
UB066 Merlin Webbing 6.6m (20ft)	190mm (7 1/2")	160mm (6 1/4")
UB100* Merlin Wire 10m (32ft)	290mm (11 7/6")	190mm (7 1/2")
UB250* Merlin Wire 25m (82ft)	390mm (15")	265mm (10")
UB251* Merlin Wire 25m (82ft) Retrieval	390mm (15")	265mm (10")
UB050 Webbing 5m (16ft)	210mm (8 1/4")	150mm (5 7/8")
UB051 Wire 5m (16ft)	210mm (8 1/4")	150mm (5 7/8")
UB170 Wire 15m (50ft)	340mm (13 3/8")	200mm (7 7/8")
UB171 Wire 15m (50ft) Retrieval	340mm (13 3/8")	200mm (7 7/8")

*Stainless Steel Wire & hooks available on request.



Progress Capture Pulleys

The latest range of ISC Progress Capture Pulleys (PCP) now feature a new lightweight centre plate, re-positioned wheel to reduce rope friction and a rated Becket, through which even an ANSI Karabiner can be fully rotated. All PCPs are fitted with tamper-proof rivets and are individually serial numbered. The cam-faces are coned, (rather than spiked), to minimise rope wear.

RP700/RP701



RP702/RP704



RP703/RP705



Features & Applications

Progress Capture Pulleys incorporate a cam which automatically captures the load whilst lifting/pulling a load or tensioning a line. To lower/release the line the cam must be manually unclamped by using the flexible Dyneema release cord and held/pinned clear of the rope during the lower/release of the line.

One-way Locking Bearings

To assist in controlling lowering/releasing of loads, the one way bearings do not turn while the load is released/lowered, thereby increasing friction and acting as a static bollard giving the operator much more control. Progress Capture Pulleys can be used in all sorts of applications, such as hauling, tensioning and work positioning of heavy loads, including bariatric work.

Technical Information

		Weight	MBS
Double Rescue Pulleys			
RP701	Standard	660g (23oz)	40kN (8992lbf)
RP700	One-way Bearings	649g (23oz)	30kN (6744lbf)
Progress Capture Pulleys - Single			
RP702	Standard	663g (23oz)	40kN (8992lbf)
RP704	One-way Bearings	655g (23oz)	30kN (6744lbf)
Progress Capture Pulleys - Double			
RP703	Standard	910g (32oz)	40kN (8992lbf)
RP705	One-way Bearings	895g (32oz)	30kN (6744lbf)





HaulerBiner™ Compact Rescue Kit



Features & Applications

The HaulerBiner™ is a mechanical advantage system, which has three pulley wheels incorporated into each Karabiner, creating a compact and lightweight 6:1 or 7:1 theoretical Mechanical Advantage system. The HaulerBiner™ has a purpose designed progress capture cam, with an 'on/off' position, which allows the cam to be held in the engaged, or disengaged position.

The HaulerBiner™ utilises purpose-developed 6mm (1/4") diameter rope, (for strength and easy handling/best grip) and is supplied in a double-pocket pouch, for easy deployment and storage on the user's harness.

The HaulerBiner™ can be used:

- As part of a pick-off system
- On a structure, pull down on the system and achieve a 6:1 (theoretical) Mechanical Advantage
- When suspended in a harness, the user can pull up on the system and achieve 7:1 (theoretical) Mechanical Advantage
- With a D4/D2 Descender, as part of a short-haul/long-lower system
- As a tensioning system for short/low load lines
- As a stretcher management device, using two or more HaulerBiners to easily change or adjust the orientation of the stretcher



The length of the system when fully contracted is only 32cm (12")

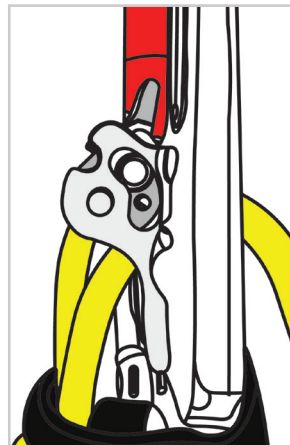

Cam Engaged
Progress Capture during lifting

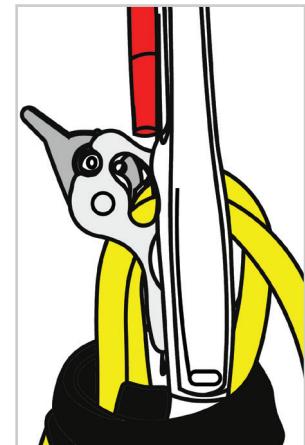

Cam Disengaged
For lowering

Technical Information

HaulerBiner™ Compact Rescue Kit

HB105 105cm (3'5") Kit		Rated Load: 140kg (308lb)
HB165 165cm (5'5") Kit		MBS: 16kN (3596lbf)
HB300 300cm (9'10") Kit		Gate Type: Supersafe (Triple-lock)
		Rope Diameter: 6mm (1/4")



R-ALF™ Rescue Auto Locking Pulley

The R-ALF™ has an over-speed brake built in so that it will automatically lock and hold when a fall occurs. The load rated becket eye can be used in combination, with a range of ISC medium prussik pulleys to set up a 3:1 pick off kit or a 5:1 hauling kit - and whichever combination is used, if the user loses control of the descent the over-speed brake will automatically engage.

RP431 R-ALF™



Features & Applications

The R-ALF™ system locks in both directions and can be set up with almost any EN1891A 11mm (7/16th) rope - the only practical limitation to 'height of lift' being rope stretch and/or kit weight.

The R-ALF™ can be used as part of a work suspension system either on tall structures or confined spaces. A user can easily lift/lower themselves and lock themselves off by using a Hand Ascender or short stop.

The unique design of the R-ALF™ means that an internal brake is not required and therefore the R-ALF™ is capable of several thousand cycles and many arrests.*

*12 month service intervals as minimum requirement



RP433 LH-ALF™

The new LH-ALF™ has brake-pawls on one side only which means that there is no restriction on hauling speed/movement, (on a normal, two-way locking R-ALF™ device, unintentional locking can occur when hauling too quickly). The one-way locking LH-ALF™ is therefore ideal in a setting where a user needs to haul quickly, such as when unloading materials from a supply vessel at an offshore wind turbine.

The LH-ALF™ is available for materials handling only. As the LH-ALF™ version does not have the bi-directional braking system, this version is not recommended for use with people.

2:1



Material Handling Only

Technical Information

			Weight	WLL
RP431	R-ALF™	Two-way Locking	1248g (44oz)	250kg (551lb)
RP433	LH-ALF™	One-way locking	1436g (44oz)	250kg (551lb)

Kits



	2:1 Kit	3:1 Kit	5:1 Kit
R-ALF™ Hauler (2-way locking)	0	✓	✓
LH-ALF™ Hauler (1-way locking)	✓	0	0
Atlas Scaffold Anchor Connector	1	1	1
Medium Single Prussik (No becket)	1	0	0
Medium Single Prussik (Becket)	0	2	0
Medium Double Prussik (Becket)	0	0	2
Professional Hand Ascender	0	1	1
Aluminium Oval Karabiner (Supersafe)	2	2	2

The above kits are supplied with a ropebag, instructions and sufficient rope to allow for 10m (32ft) height of lift (HOL)- other HOL available on request*

*Rope bag style varies, depending on volume of rope in kit.

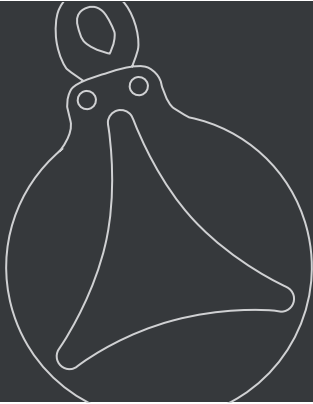

ALF™ Climb Assist Pulley

The ALF™ is designed for climbing vertical structures such as ladders and is ideal for use in Ropes Courses. Fall distance is limited to a few centimetres. Rescue is made easy with the ALF™ - fall distances are extremely small so it is unlikely that a person will be incapacitated, but if this happens, a rescue can easily be effected from ground level, unlike the majority of fall arrest devices where a rescuer must climb up, (therefore putting himself at risk) to make the rescue.

How it Works

The ALF™ Climb Assist Pulley uses a uniquely designed locking system, which combines a speed sensitive inertia locking brake system, with a grooved pulley wheel. At low speed (during normal use), the rope runs freely through the pulley. In the event of a fall, the rope speed increases causing the brake to lock to promptly arrest the fall. Fall distances are extremely short, so in most cases the fallen user can regain their grip on the structure and resume the climb, without the need for assistance/instruction.

The ALF™ Pulley is a two-way locking device which can be rigged in a continuous loop system with Alpine Butterfly attachment loops at opposing ends of the system. This means that at the end of each climb/descent, there is always an attachment loop present, allowing the next user to immediately commence their climb/descent.



Rigging



RP430 ALF™



WLL 140kg



Applications

The ALF™ Climb Assist Pulley was developed for users in the Challenge Course Industry, who needed a simple mechanical method of protecting multiple climbers en route around a ropes course. The ALF™ provides a simple, cost effective solution, which utilises industry standard (EN1891) low stretch 11mm (7/16") rope. The continuous loop system can be quickly and easily rigged, by a competent person.

The ALF™ Climb Assist Pulley can also be used as a solution for workers on towers & masts, wind turbines and in construction applications.

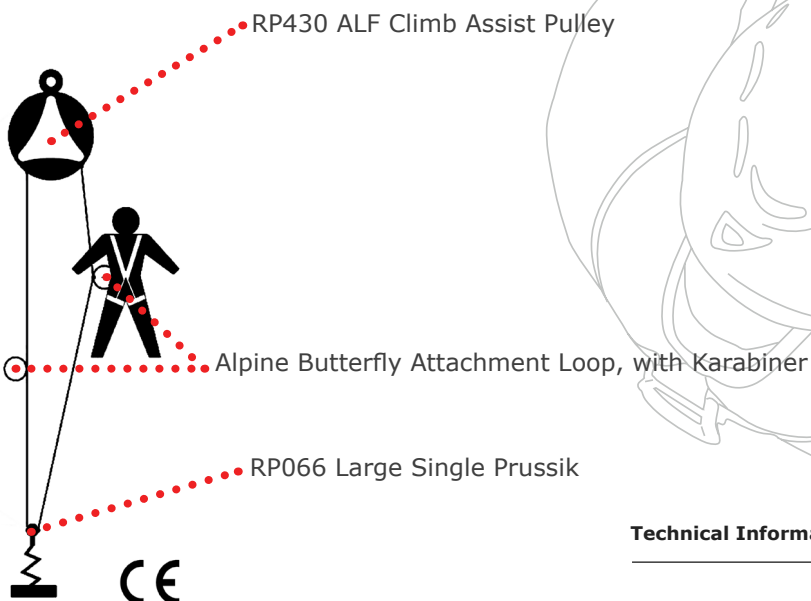

Technical Information

		Weight	WLL
RP430	ALF™ Climb Assist Pulley	1.2kg (42oz)	140kg (310lb)



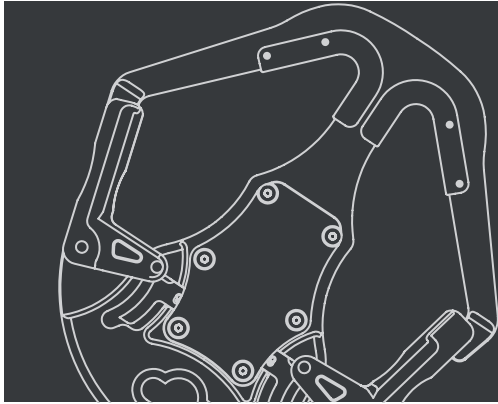

SmartSnap™ (Continuous Attachment Device)



SmartSnap™ is a self-belay system which allows the user to traverse all of the individual elements of a course without ever being able to detach from the line. SmartSnap™ is really simple to use and therefore doesn't require in depth user training; it is lightweight and is therefore perfectly suitable for children to use. The SmartSnap™ has been designed so that it can easily be retro-fitted to an existing course.

How it Works

The SmartSnap™ has two locking gates which are controlled by a mechanism which only allows one gate to open at any one time. Each course user wears a SmartSnap™ Device, attached to their harness by a short lanyard. At the beginning of the course, the Supervisor attaches the Blue gate of the SmartSnap™ to the wire (Figure 1) and locks the gate, using the wire-mounted key (Figure 2). The user then travels to the next change-over point, where they clip the Red gate on to the Ring Key lanyard (Figure 3). The user then inserts the spike of the Ring Key in to a hole (Figure 4). This action simultaneously locks the Red gate AND unlocks the Blue gate, releasing the user from the previous element, leaving them safely attached to the next element (Figure 5).

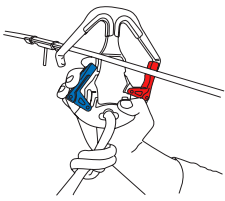

Fig 1

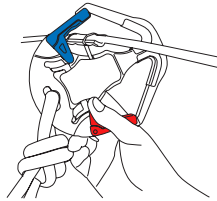

Fig 2

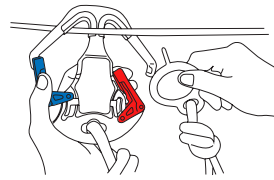

Fig 3

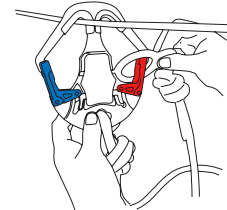

Fig 4

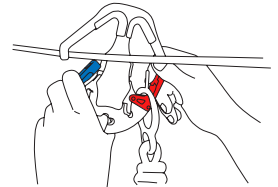

Fig 5



KY004 Ring Key



KY005 Wire Key

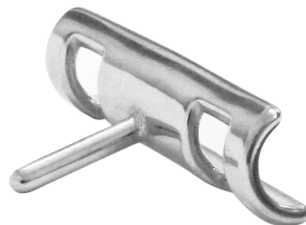

Technical Information

		Weight	MBS
RP420	SmartSnap™	330g (12oz)	25kN (5620lbf)
KY004A	Ring Key (Stainless Steel)	130g (5oz)	25kN (5620lbf)
KY005A	Wire Key (Stainless Steel) [For 13mm (1/2") wire]	36g (1oz)	N/A (N/A)
KY005B	Wire Key (Stainless Steel) [For 10mm (3/8") wire]	36g (1oz)	N/A (N/A)



13mmMAX

I/S/C

ZIPPEY
CLIP & TIE

DO NOT REMOVE COVER

RP420
MBS 125kN



SmartSnap™

Manufactured in UK by I/S/C

14154036/18

CE0120 EN362:04T

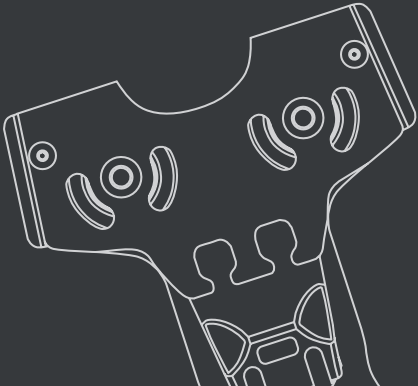
Zippey™ Clip 'n' Zip



Why Zippey™ Clip 'n' Zip? This new compact trolley has been introduced to compete with lightweight one-handed fitting trolleys. Often the trolleys for this end of the market are 'low-cost' or 'budget' options, which suffer the common problems of premature wear (due to poor materials), short bearing life (due to poor quality bearings) and offer very few features.

RP074



Hooked End Stops

Features & Applications

Having consulted zipline operators from around the world throughout the development of the Zippey™, we have succeeded in incorporating all of the positive features needed to overcome the challenges faced by the industry.

Zippey™ is manufactured from high-spec 4mm Aluminium plate, has a Forged Aluminium gate, (which incorporates a Stainless Steel closure spring), and is fitted with Stainless Steel Wheels (with a unique option of greasable bearings for increased longevity in harsh environments) and Stainless Steel wheels; all of which offer the best weight to performance ratio on the market.



Flat End Stops

Features & Applications

Easy one-handed operation

The Zippey™ is bi-directional, (so there's no wrong way to fit it) and offers a one handed double locking mechanism for increased safety. The simple, secure spring-loaded double locking gate can be operated with finger or thumb.

Choice of end stops

Zippey™ has replacable end-stops (bumpers), which are made from highly durable Impact Modified Nylon. Zippey™ can be supplied with the standard flat end stops, or with hooked end stops (optional extra). Hook end stops allow a secondary lanyard to be mounted.

New!

ARC (Anti - Rollback Cam) available see page 51

Technical Information

	Weight	MBS	Max Cable
RP074	450g (1lb)	25kN (5620lbf)	13mm (1/2")

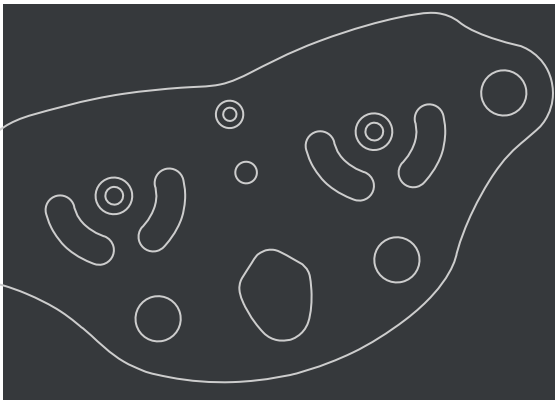

ZipSpeed Trolleys & Accessories

The NEW ISC ZipSpeed Tandems represent industry leading Zipline Trolley innovation at its most affordable! The design of these mid-size trolleys uses state of the art engineering techniques and high-performance components to ensure that they run and run. They offer several unique features. All these trolleys have been extensively trialled and are in use at several major parks around the world. These are possibly the fastest, strongest & most durable Zipline Trolleys available.

RP075



RP076



Features & Applications

ZipSpeed Trolleys are fitted with special Rubber-sealed, Deep Groove Ball Bearings as Standard. These Bearings have been chosen for optimal high speed, low friction performance. The rubber seals retain the grease lubricant, whilst defending the Bearings from moisture and contaminants; giving the ZipSpeed a lifespan of thousands of miles/kilometres.

The ZipSpeed Trolleys are fitted with a rubber brake buffer to absorb impact load at the end of the run. The Trolleys have several attachment hole options, including an extra large central attachment hole which will accommodate a wide range of Karabiners and Snaphooks. The rear attachment hole can be used to attach a secondary lanyard or specialist harness and the centre hole can be used to attach a hanger bar.



13mm (1/2") Wire



16mm (5/8") Wire



20mm (3/4") Wire



ZipSpeed Trolleys are available with 50mm (2") or 75mm (3") Diameter Wheels, to suit lines of varying tension, gradients & speeds. We also offer versions to suit 13mm (1/2"), 16mm (5/8") or 20mm (3/4") wires and each Trolley is fitted with a colour coded collar for quick, easy identification.

(We recommend the use of Aluminium (KH204) or Steel (KH212) HMS Karabiners with these Trolleys). See pages 58-60 for more details.

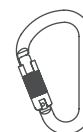

KH212

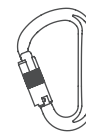

KH204

Specialist Deep Groove Ball Bearings, chosen for optimal high speed, low friction performance.

Technical Information

	Wire Size	Weight	MBS
50mm (2") Diameter Wheels			
RP075A	13mm (1/2") Wire	872g (31oz)	40kN (8992lbf)
RP075B	16mm (5/8") Wire	872g (31oz)	40kN (8992lbf)
RP075G	20mm (3/4") Wire	872g (31oz)	40kN (8992lbf)
75mm (3") Diameter Wheels			
RP076A	13mm (1/2") Wire	1810g (64oz)	40kN (8992lbf)
RP076B	16mm (5/8") Wire	1810g (64oz)	40kN (8992lbf)
RP076G	20mm (3/4") Wire	1810g (64oz)	40kN (8992lbf)



Zip/Adventure Park Accessories

We offer a comprehensive range of products for the Adventure Park sector. We offer a huge selection of devices and accessories for super-fast high-throughput courses, to smaller clip-on-clip-off courses.

Anti-Rollback Cam (ARC)

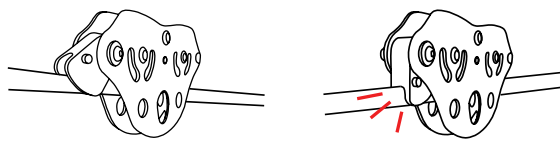

Cam in neutral 'trailing' position

Cam activated

World's first patented trailing Anti-Rollback Cam (ARC)

5CM-LRA101

Standard Length Range:
Minimum 600mm (24") - Maximum 900mm (35")



5AB - ZLS Superman Harness



Features & Applications

The Anti-Rollback Cam is a simple device which can be retro-fitted to the ZipSpeed and Zippey Trolleys. During normal use, the cam trails, allowing the trolley to roll forwards, unhindered. However, as soon as the trolley begins to roll backwards, the cam is activated, bringing the trolley to an immediate halt. This anti-rollback function captures the progress of the trolley, which means that even when the trolley doesn't reach the end of the zipline, it cannot roll backward and hence rescue distance (and therefore, rescue time) is significantly reduced.

5AB-ZLH Parachute Sit Harness



Various sizes available



© Photo Courtesy of Aerial View Photography



RP029



The first and only Stainless Steel Shear Reduction Block to be CE Approved to the PPE Directive.

Fixed Wheel Shear Reduction Block

The ISC Shear Reduction Block (RP029) and Fixed Wheel Stainless Prussiks (RP063F) are the first and only stainless Steel Shear Reduction Blocks to be CE Approved for use as Personal Protective Equipment (PPE). This CE Approval means that the buyer/user is guaranteed that the block meets/exceeds the requirements laid down in the PPE Directive.

Features & Applications

The RP029 Shear Reduction Pulley has Stainless Steel wheel and cheeks and is fitted with a top bollard attachment point. The top bollard has been designed to be compatible with a standard 10mm (approx 3/8") long opening Maillon Rapide.

The Wheel of the Pulley does not rotate, thus giving maximum friction. The increased friction makes this pulley ideal for increased control when used in lowering applications such as top roping in Climbing Walls/Gyms and Ropes Courses.

Each Pulley is serial marked for ease of traceability.

Eiger Lightweight Pulleys

ISC lightweight Eiger Pulleys are made from high strength Aluminium and fitted with tamper-proof rivets. ISC Eiger Pulleys are fitted with MOS2 Impregnated Bushings, which are ideal in lightweight applications.

RP012



RP030



RP031



RP032



RP033



RP034



RP037



Technical Information

Type	Wheel Material	Max Rope Ø	MBS	Weight	
Shear Reduction Pulley					
RP029	Fixed Wheel Shear Reduction Block	Stainless Steel	13mm (1/2")	44kN (9891lbf)	820g (29oz)
RP063F	Fixed Wheel Shear Reduction Prussik	Stainless Steel	13mm (1/2")	50kN (11240lbf)	584g (21oz)
Eiger Pulleys					
RP012	Small Single	Aluminium	13mm (1/2")	36kN (8093lbf)	87g (3oz)
RP030	Small Double	Aluminium	13mm (1/2")	35kN (7868lbf)	150g (6oz)
RP031	Double Re-direct	Aluminium	13mm (1/2")	30kN (6744lbf)	126g (5oz)
RP032	Medium Single	Aluminium	13mm (1/2")	36kN (8093lbf)	158g (6oz)
RP033	Medium Double	Aluminium	13mm (1/2")	36kN (8093lbf)	284g (10oz)
RP034	Medium Single (Double Ended)	Aluminium	13mm (1/2")	36kN (8093lbf)	181g (6oz)
RP037	Micro Pulley (12kN Rated Bridge)	Aluminium	13mm (1/2")	28kN (6295lbf)	90g (3oz)



101

MBS
70kN



35kN

35kN

EN12278:07
Ø 5-18 mm

IIS/C

RP066

12/25994/33

CE 0120





Heavy Duty Prussiks

All pulleys in our latest Prussik range have tamper-proof Rivets, in compliance with CE EN12278 (2007) & NFPA (1983). These pulleys are available with MOS2 Impregnated Bushings, or Roller Bearings. ISC Prussiks have load rated becketts, which are large enough to allow a Karabiner to rotate fully.

Single Prussik



Single with Becket



Double Prussik



Bushings



Ideal for high loads at low speeds

Roller Bearings



Ideal for low loads at high speeds

Prussik Pulleys - Aluminium

Technical Information

	Type	Wheel Material	Max Rope Ø	MBS	Weight
RP060	Small Single	Aluminium	13mm (1/2")	40kN (8992lbf)	200g (7oz)
RP061	Small Double	Aluminium	13mm (1/2")	40kN (8992lbf)	360g (13oz)
RP063	Medium Single	Aluminium	13mm (1/2")	50kN (11240lbf)	318g (11oz)
RP064	Medium Double	Aluminium	13mm (1/2")	50kN (11240lbf)	554g (19oz)
RP065	Medium Single with Becket	Aluminium	13mm (1/2")	50kN (11240lbf)	331g (8oz)
RP068	Large Single with Becket	Aluminium	16mm (5/8")	70kN (15736lbf)	486g (17oz)
RP066	Large Single	Aluminium	16mm (5/8")	70kN (15736lbf)	465g (17oz)
RP067	Large Double	Aluminium	16mm (5/8")	70kN (15736lbf)	760g (27oz)
RP069	Extra Large Single	Aluminium	19mm (3/4")	70kN (15736lbf)	440g (16oz)

Prussik Pulleys - Stainless Steel

Technical Information

	Type	Wheel Material	Max Rope Ø	MBS	Weight
RP060	Small Single	Stainless Steel	13mm (1/2")	40kN (8992lbf)	372g (14oz)
RP061	Small Double	Stainless Steel	13mm (1/2")	40kN (8992lbf)	674g (24oz)
RP063	Medium Single	Stainless Steel	13mm (1/2")	50kN (11240lbf)	584g (21oz)
RP064	Medium Double	Stainless Steel	13mm (1/2")	50kN (11240lbf)	1036g (37oz)
RP065	Medium Single with Becket	Stainless Steel	13mm (1/2")	50kN (11240lbf)	413g (15oz)
RP066	Large Single	Stainless Steel	16mm (5/8")	50kN (11240lbf)	896g (32oz)
RP067	Large Double	Stainless Steel	16mm (5/8")	50kN (11240lbf)	1626g (58oz)



TRIED, TESTED...

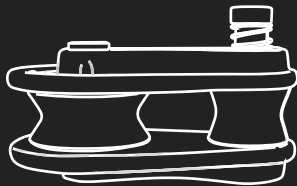

ISC Rigging Blocks have colour-coded Side Cheeks and Pulley Wheels, helping the user to easily identify the correct block for the task. We have introduced a new fixed bollard dimension, which allows the user to fall in-line with rigging standard practice, whereby the Anchor/Topping Strop should be twice the strength of the Working Line.

Features



Rounded Plates
Smooth edges minimise rope wear



Markings Plate
Quick, easy Pulley Identification

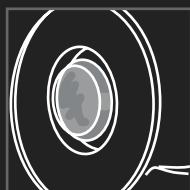

Chamfered Pin Head
For quick, easy location of the Spring-lock Pin



Wider Profile
Accommodates larger topping strops



RP048

New!



RP050



RP051

















RP054



RP055



Colour Coding

	Side Cheeks	Pulley Wheel
RP048		
RP050		
RP051		
RP054		
RP055		
RP056		
RP057		

RP056 Flame



RP057



Technical Information

	WLL	Working Line		Topping Strop*		Unit weight
		Size	MBS	Size	MBS	
RP048	1700kg (3800lb)	13mm (1/2")	8500kgf (19000lbf)	16mm (5/8")	7400kgf (16650lbf)	0.5kg (1lb)
RP050	2000kg (4400lb)	13mm (1/2")	4500kgf (9900lbf)	19mm (3/4")	10630kgf (24000lbf)	1.6kg (3.5lb)
RP051	2000kg (4400lb)	16mm (5/8")	7720kgf (17000lbf)	25mm (1")	17180kgf (37800lbf)	1.6kg (3.5lb)
RP054	3000kg (6600lb)	16mm (5/8")	7720kgf (17000lbf)	25mm (1")	17180kgf (37800lbf)	2.5kg (5lb)
RP055	3000kg (6600lb)	19mm (3/4")	10630kgf (24000lbf)	29mm (1 1/8")	21270kgf (46800lbf)	2.3kg (5lb)
RP056	2000kg (4400lb)	16mm (5/8")	7720kgf (17000lbf)	25mm (1")	17180kgf (37800lbf)	1.6kg (3.5lb)
RP057	4000kg (8800lb)	19mm (3/4")	10630kgf (24000lbf)	29mm (1 1/8")	21270kgf (46800lbf)	3.8kg (8.5lb)

*Based on Yale Polydyne and Double Esterlon



Rope Wrench

The Singing Tree Rope Wrench (STRW) creates a 'bend' above the climber's hitch on the single line which, with the addition of the tether to connect the STRW, creates a 'contained doubled rope system' on a single line. This 'contained double rope system' travels with the climber allowing for a level of consistency of friction on the hitch, which is impossible to duplicate in double rope climbing.

RP280



How it works

The Rope Wrench is a unique and innovative device, designed by Kevin Bingham of Singing Tree.

Rope Wrench colours available with matching RP281 Pulley



RP280 Weight 126g (5oz)

The STRW allows so many more options for safe movement in the tree whilst using a single Rope, enabling re-directs and a greater degree of friction control than that achieved using double rope.

The STRW allows far greater flexibility and opens up a wide range of new working possibilities. In double rope climbing, friction levels never remain constant due to rope running over limbs, redirects and Pulleys. The STRW allows for single rope climbing and therefore friction always remains consistent, which allows the user precise control in the tree, without creating excess slack in the system (as can occur in double rope technique). The STRW also allows the user to easily pass any limbs which obstruct their route - it is possible to pass obstructions when using DRT, but it can be a very tricky manoeuvre!

ZK-2 New Features

The smaller, lighter design works well with the stiff tether, which keeps the STRW away from the hitch. The ZK-2 Rope Wrench is detachable, by way of a Slic-pin. The introduction of a Pulley wheel keeps the rope round, so there's less rope flattening than with the ZK-1 version.

Note: The STRW is not for primary life support. The hitch provides the primary life support.

When supplied without a factory-fitted tether, the Rope Wrench cannot feature a CE mark and can only be sold into countries where CE marking is not mandatory (e.g. USA) and also where the customers in those countries are not therefore required to buy the approved tether.



The Rope Wrench Kits are now marked with a CE Mark. This CE marking is certified under the PPE Directive 89/686/EEC and EN12278 Pulley Standard and, for unavoidable reasons of test methodology, it applies to a **combination of Tether and Wrench**.

Testing was carried out with an MBS of 24kN (5395lbf), which additionally means that the combination of tether and Rope Wrench exceeds the ANSI minimum strength test criteria of 5000lbs. Dealers and users should be aware that other tethers may not meet this strength requirement.



CE



1. Rope Wrench & Single Leg Tether

RP280XX+RT270B1

(shown here with RP281 Parallel Pulley)



CE

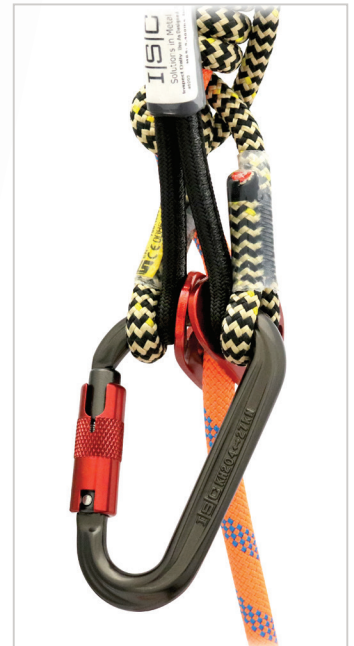

2. Rope Wrench & NEW Twin-leg Tether

RP280XX+RT270C1

(shown here with RP012 Cranked Pulley)



Aluminium Karabiners

ISC Performance Karabiners are Forged for best build quality and feature a unique 'Blind' nose, which improves performance by reducing snagging. The Barrels have been designed with a square cut notch to limit debris build up. ISC Aluminium Karabiners are of sleek ergonomic design, with a high strength to weight ratio.

Options +



Captive Pin Available

Captive pins can be fitted to keep lanyard/webbing in place, to prevent unwanted rotation, therefore reducing the risk of side loading.



Blind Nose (Unique to ISC)

ISC Performance Karabiners are forged with a blind nose, to prevent snagging.



Keylock Nose

We have now introduced the process of cold forging, which allows us to offer keylock (anti-snag) noses on several Karabiners in our range.



Fall Indicator Available

Swivel-eye Karabiners can be supplied with fall indicators. In the event of a fall, the red ring is exposed, alerting the user that a fall has taken place.

Serial Numbering YY/BBBBB/XXXX

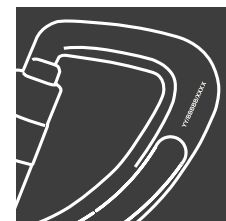

YY: Year of Manufacture

BBBBB: Batch Number

XXXX: Individual Serial Number

ISC Aluminium Connectors are laser marked with Serial numbers as standard, for ease of traceability.

Colour Coded

ISC Aluminium Karabiners have colour-coded Barrels/Ferrules for quick, easy identification.



Screwgate

Unscrew, open



Twistlock

(double-action)

Turn, open



Supersafe

(Triple-action)

Lift, turn, open



Quadlock

(Quad-action)

Turn, lift, turn, open

Technical Information

	Name	Height	Width
KH214	Mini HMS	102mm (4")	74mm (3")
KH204	HMS	124mm (4 7/8")	78mm (3 1/3")
KH411	Luke Oval	112mm (4 3/8")	70mm (2 3/4")
KH453	Gator	105mm (4 1/8")	65mm (2 1/2")
KH452	Gecko	115mm (4 1/2")	75mm (3")
KH451	Mongoose	133mm (5 1/4")	88mm (3 1/2")
KH301	Captive Eye	137mm (5 3/8")	75mm (3")
KH215	Link	113mm (4 1/2")	61mm (2 3/8")
KH255	Twister	175mm (6 7/8")	72mm (2 7/8")

Bentgate Karabiners

NOT FOR PPE

Bentgate Karabiners are not for use as PPE purposes and are marked accordingly. The KH453 Gator Bentgate is ideal for use as a Toolhook and the KH204 HMS Bentgate is ideal for use in Wheelchair Restraints.

KH453BG Gator Karabiner



KH204BG HMS Karabiner

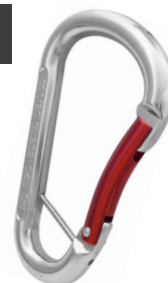



KH214 Mini HMS



Weight 98g (3.5oz)
Gate Opening 19mm (3/4")
MBS 27kN (6070lbf)

KH204 HMS



Weight 103g (3.6oz)
Gate Opening 19mm (3/4")
MBS 27kN (6070lbf)

KH411 Luke Oval



Weight 80g (2.8oz)
Gate Opening 20mm (3/4")
MBS 25kN (5620lbf)

KH453 Gator



Weight 47g (1.7oz)
Gate Opening 15mm (7/8")
MBS 25kN (5620lbf)

KH452 Gecko



Weight 86g (3oz)
Gate Opening 21mm (7/8")
MBS 30kN (6744lbf)

KH451 Mongoose

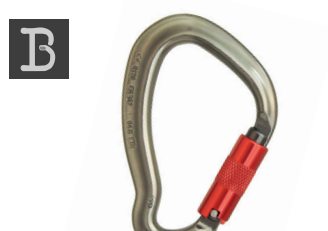

Weight 118g (3.5oz)
Gate Opening 24mm (1")
MBS 30kN (6744lbf)

KH300 Captive Eye



Weight 99g (3.5oz)
Gate Opening 20mm (3/4")
MBS 30kN (6744lbf)

KH215 Link



Weight 85g (3oz)
Gate Opening 15mm (5/8")
MBS 25kN (5620lbf)

KH255 Twister



Weight 142g (5oz)
Gate Opening 15mm (5/8")
MBS 27kN (6070lbf)

(Gate openings based on SS gate)



Steel Karabiners



KH219 Iron wizard



Side Opening



Weight 264g (9.3oz)
Gate Opening 28mm (1 1/8")
MBS 70kN (15736lbf)

KH455 Big Dan



Weight 365g (12.9oz)
Gate Opening 27mm (1 1/8")
MBS 50kN (11240lbf)

KH212 HMS



Weight 276g (9.7oz)
Gate Opening 23mm (7/8")
MBS 50kN (11240lbf)

KL308 D Shape



Weight 175g (6.2oz)
Gate Opening 17mm (5/8")
MBS 35kN (7868lbf)

KL200 Offset D



Weight 280g (10oz)
Gate Opening 20mm (3/4")
MBS 50kN (11240lbf)

KH260 Twister



Weight 408g (14oz)
Gate Opening 18mm (3/4")
MBS 40kN (8992lbf)

KH415 Iron Wizard large



Weight 540g (19oz)
Gate Opening 33mm (1 1/4")
MBS 70kN (15736lbf)

KH400 Atlas



Weight 720g (25oz)
Gate Opening 57mm (2 1/4")
MBS 45kN (10116lbf)

KH407 Scaffold Hook



Weight 678g (23.9oz)
Gate Opening 53mm (2 1/8")
MBS 35kN (7868lbf)

Gate Options



Screwgate

Unscrew, open



Twistlock

(double-action)

Turn, open



Supersafe

(Triple-action)

Lift, turn, open



Quadlock

(Quad-action)

Turn, lift, turn, open



KH311 Oval



Weight 188g (6.7oz)
Gate Opening 17mm (5/8")
MBS 25kN (5620lbf)
 (Screwgate version is not available in Keylock)

KL311



Weight 190g (6.7oz)
Gate Opening 16mm (5/8")
MBS 25kN (5620lbf)

KL321 Offset Oval



Weight 193g (6.8oz)
Gate Opening 17mm (5/8")
MBS 40kN (8992lbf)

KH301 Captive Eye



Weight 261g (9.2oz)
Gate Opening 18mm (3/4")
MBS 50kN (11240lbf)

KL202 Klettersteig



Weight 250g (8.8oz)
Gate Opening 26mm (1")
MBS 50kN (11240lbf)

KH307 Firemans



Side Opening



Weight 405g (14.2oz)
Gate Opening 43mm (1 3/4")
MBS 40kN (8992lbf)

Dot Matrixing Serial Numbering

Dot Matrix serial number markings are included as standard on all our Steel and Stainless Steel Connectors. This marking method provides permanent, highly wear-resistant markings, for traceability throughout the lifespan of the product.

YY/BBBB/XXXX

YY: Year of Manufacture
BBBB: Batch Number
XXXX: Individual Serial Number

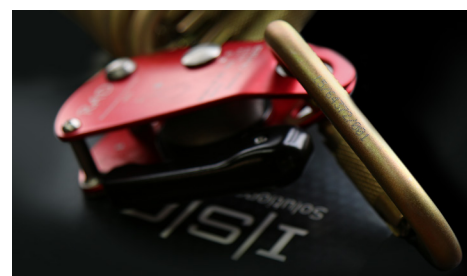

Options +



ANSI Compliant Barrels



Captive Pin Available



Blind Nose (Unique to ISC)



Keylock Nose



Fall Indicator Available

Technical Information

		Height	Width
KH219	Iron Wizard (S)	125mm (4 7/8")	72mm (2 7/8")
KH455	Big Dan	137mm (5 3/8")	86mm (3 3/8")
KH212	HMS	127mm (5")	80mm (3 1/8")
KL308	D Shape	105mm (4 1/8")	55mm (2 1/8")
KL200	Offset D	113mm (4 1/2")	63mm (2 1/2")
KH260	Twister	175mm (6 7/8")	75mm (3")
KH415	Iron Wizard (L)	180mm (7")	102mm (4")
KH400	Atlas	200mm (7 7/8")	145mm (5 3/4")
KH407	Scaffold	240mm (9 1/2")	135mm (5 3/8")
KH311	Oval	106mm (4 1/8")	58mm (2 1/4")
KL311	Oval	108mm (4 1/4")	58mm (2 1/4")
KL321	Offset Oval	109mm (4 1/4")	62mm (2 1/4")
KH301	Captive Eye (S)	136mm (5 3/8")	76mm (3")
KL202	Klettersteig	125mm (4 7/8")	85mm (3 3/8")
KH307	Firemans	173mm (6 7/8")	95mm (3 3/4")

(Gate openings based on SS gate)



Stainless Steel Karabiners



KH200 Offset D



Weight 255g (9oz)
Gate Opening 20mm (3/4")
MBS 35kN (7868lbf)

KH308 D Shape



Weight 174g (6oz)
Gate Opening 16mm (5/8")
MBS 22kN (4946lbf)

KH219 Wizard



Weight 286g (10oz)
Gate Opening 28mm (1 1/8")
MBS 50kN (11240lbf)

KH307 Firemans



Weight 400g (14oz)
Gate Opening 48mm (1 7/8")
MBS 40kN (8992lbf)

KH202 Klettersteig



Weight 269g (9.5oz)
Gate Opening 22mm (7/8")
MBS 35kN (7868lbf)

KH250 Twister



Weight 374g (13oz)
Gate Opening 18mm (3/4")
MBS 23kN (5171lbf)

Gate Options



Screwgate

Unscrew, open

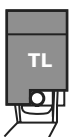

Twistlock

(double-action)

Turn, open

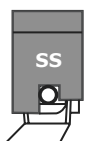

Supersafe

(Triple-action)

Lift, turn, open



Quadlock

(Quad-action)

Turn, lift, turn, open

Options +



Captive Pin Available

Captive pins can be fitted to keep lanyard/webbing in place, to prevent unwanted rotation, therefore reducing the risk of side loading.



Blind Nose (Unique to ISC)

ISC Performance Karabiners are forged with a blind nose, to prevent snagging.



Keylock Nose

The process of cold forging, which allows us to offer keylock (anti-snap) noses on several Karabiners in our range.



Fall Indicator Available

In the event of a fall, the red ring is exposed, alerting the user that a fall has taken place.



ANSI Compliant Barrels

ANSI Compliant (3600lb) Barrels Available on request.

(Gate openings based on SS gate)



3



Triple-action gate

Small Aluminium Snaphooks are available with the ISC Unique (patented) Triple-action gates for increased security.

Serial Numbering



ISC Aluminium Snaphooks are laser marked with serial numbers as standard, for ease of traceability.

Fall Indicator



Swivel-eye Karabiners can be supplied with fall indicating rings. In the event of a fall, the red ring is exposed, alerting the user that a fall has taken place.

SH901

B



SH903

3
B



SH904

F
B



SH905

3
B
F



SH901P

3
B



Stainless Steel
(Triple-lock version also available)

SH826

F
B



SH827i

ANSI
F
B

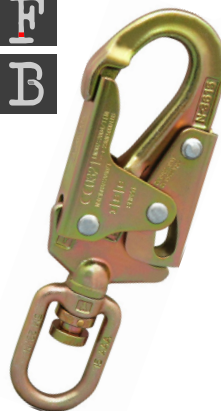

NEW!

SH824

B



SH979



SH999

(Locking nose)



Technical Information

	Type	Weight	MBS	Gate Opening
SH901	Double Action Standard Snaphook (Aluminium)	130g (4.6oz)	27kN (6070lbf)	23mm (7/8")
SH903	Triple Action Standard Snaphook (Aluminium)	135g (4.8oz)	27kN (6070lbf)	23mm (7/8")
SH904	Double Action Swivel Snaphook (Aluminium)	191g (7.0oz)	27kN (6070lbf)	22mm (7/8")
SH905	Triple Action Swivel Snaphook (Aluminium)	200g (7.2oz)	27kN (6070lbf)	22mm (7/8")
SH901P	Double Action Standard Snaphook (Stainless Steel)	323g (11.5oz)	27kN (6070lbf)	26mm (1")
SH826	Double Action Swivel Snaphook (Steel)	370g (13oz)	30kN (6744lbf)	20mm (3/4")
SH827i	Double Action Swivel Snaphook (Steel)	514g (18oz)	23kN (5170lbf)	23mm (7/8")
SH824	Double Action Standard Snaphook (Steel)	287g (10oz)	27kN (6070lbf)	21mm (7/8")
SH979	Double Action Large Scaffold Snaphook (Aluminium)	514g (18oz)	25kN (6070lbf)	65mm (2 1/4")
SH999	Double Action Large Scaffold Snaphook (Aluminium)	495g (17oz)	35kN (7868lbf)	60mm (2 3/8")





Tactical/Military Products

We offer a wide range of specialist tactical coatings across the majority of our Karabiners, Pulleys and specialist Ascent and Descent devices. Our range caters for Special Forces, Black Tactical, Military and NATO operations.



Matt Black



Sand



Olive Drab



climb.
work.
rescue.



Specialist finishes are available across a range of products including Karabiners, Pulleys & specialist devices. Please contact us to discuss your requirements.

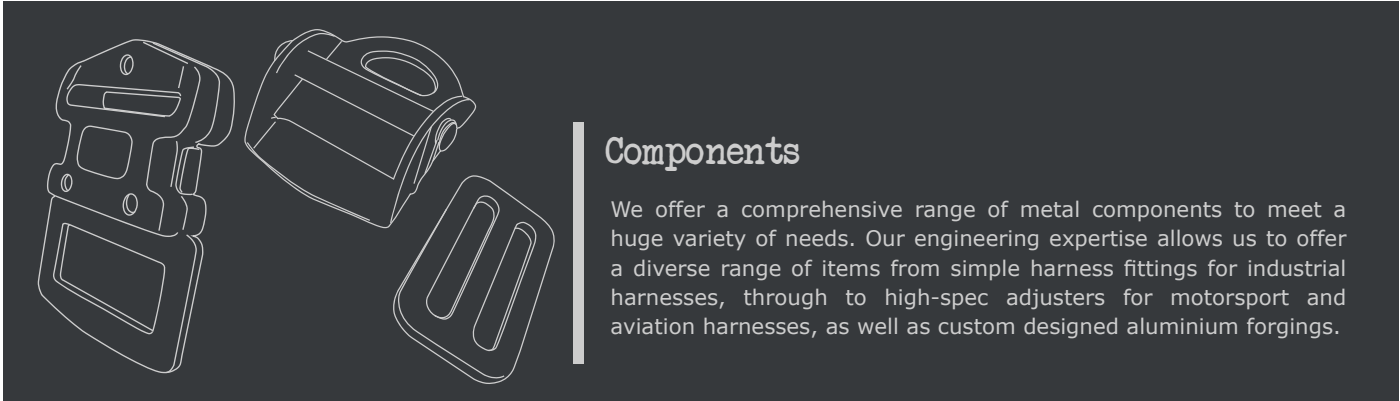

Components

We offer a comprehensive range of metal components to meet a huge variety of needs. Our engineering expertise allows us to offer a diverse range of items from simple harness fittings for industrial harnesses, through to high-spec adjusters for motorsport and aviation harnesses, as well as custom designed aluminium forgings.

Web Adjuster Buckles



Technical Information

	Buckle Size	Weight
BU170 Aluminium	45mm (1 3/4")	60g (2.1oz)
BU171 Aluminium	75mm (3")	112g (4.0oz)
BU173 Steel	75mm (3")	100g (3.5oz)
BU174 Steel	45mm (1 3/4")	65g (2.3oz)

Klick-lock Buckles

ISC Klick-lock Buckles can only be opened when both release buttons are fully depressed, this feature reduces the risk of accidental opening. When loaded, ISC buckles cannot be opened by hand, (even when both buttons are depressed).

ISC Klick-lock Buckles are tested without webbing, in a straight line (direct pull), in line with the Z359.1 ANSI Standard. This method gives an accurate, genuine measure of strength.

Some manufacturers test the buckles as part of webbing loop which can give misleading results (see diagram).

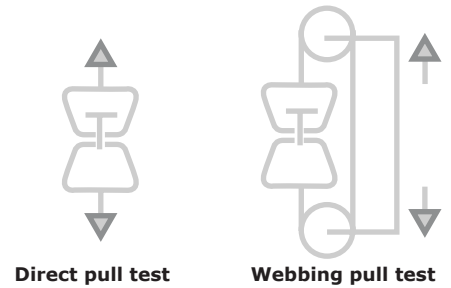

Technical Information

	Buckle Size	Tang Size	Weight
Supplied with Tang & 3 Bar Slide - 20kN (4496lbf)			
BU180	45mm (1 3/4")	45mm (1 3/4")	138g (4.9oz)
BU183	25mm (1")	45mm (1 3/4")	124g (4.4oz)
Supplied with Sliding Bar Tang - 16kN (3597lbf)			
BU182	45mm (1 3/4")	45mm (1 3/4")	120g (4.2oz)
BU184	25mm (1")	45mm (1 3/4")	108g (3.9oz)
BU185	25mm (1")	25mm (1")	94g (3.3oz)
Supplied with Tang & 3 Bar Slide - 12kN (2697lbf)			
BU190	45mm (1 3/4")	45mm (1 3/4")	248g (8.7oz)

BU190

Stainless Steel



Black versions also available



BU102/BU106



3 Bar Slides -Stainless Steel
BU102

Size 45mm (1 3/4")
Weight 30g (1oz)

BU106

Size 50mm (1 3/4")
Weight 40g (1.4oz)

BL121/BL122



Square Links - Stainless Steel
BL121

Size 45mm (1 3/4")
Weight 35g (1.2oz)

BL122

Size 45mm (1 3/4")
Weight 35g (1.2oz)

BU102G



3 Bar Slide - Steel
Size 45mm (1 3/4")
Weight 30g (1oz)

BU121E



3 Bar Slide - Steel
Size 45mm (1 3/4")
Weight 34g (1.2oz)

BU200



3 Bar Slide - Steel
Size 45mm (1 3/4")
Weight 46g (1.6oz)

BU101



Heavy Duty 3-Bar slide - Steel
Size 75mm (3")
Weight 102g (3.4oz)

AP184



Sliding 3 Bar - Steel
Size 45mm (1 3/4")
Weight 48g (1.7oz)

SH101



Compact Hook
Size 50mm (2")
Weight 78g (2.8oz)

DD302



Pressed Delta
Size 45mm (1 3/4")
Weight 72g (2.5oz)

BD304



D-Ring - Steel (Flat)
Size 50mm (2")
Weight 76g (2.7oz)

BU160



Knurled Bar Buckle - Steel
Size 45mm (1 3/4")
Weight 53g (1.8oz)

BD600C



D-Ring Aluminium (Cranked)
Size 45mm (1 3/4")
Weight 80g (2.8oz)
MBS 25kN (5620lbf)

BD600D



D-Ring Aluminium (Flat)
Size 45mm (1 3/4")
Weight 80g (2.8oz)
MBS 25kN (5620lbf)

Steel Rings

MBS 70kN (15736lbf)

Aluminium Rings

MBS 25kN (5620lbf)

RIN0012



Small Ring
Internal Diameter 27mm (1 1/8")
Outside Diameter 51mm (2")

RIN0013



RIN0010



Large Ring
Internal Diameter 45mm (1 3/4")
Outside Diameter 70mm (2 3/4")

RIN0011



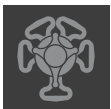

Quick Release Buckles (QRBs)

ISC manufacture a wide range of Quick Release Buckles for the Motor Racing Industry, to suit FIA/SFI standard requirements.

Body Type

ISC QRBs are available with standard or Streamline (light & compact) bodies, which are machined from Aerospace Grade Aluminium.

Tang Release

QRBs fitted with a Rotary mechanism release their tangs as soon as the user begins to rotate the lid. With the Lost Motion mechanism, the lid must be turned 25° in either direction, before the mechanism disengages and begins to release the tangs. Lost Motion helps to prevent accidental opening.

Positioning

QRBs can be supplied with a fixed tang in one of three positions, to allow for driver preference. When the QRB locking mechanism is disengaged, four tangs are discarded from the QRB, with the fifth tang remaining permanently fixed in to the device. The term 'Tang Position' refers to the position of the one tang which remains permanently fixed to the device.

Opening/closing Mechanisms

QRBs are available with parking or non-parking opening mechanisms. When opened, a 'parking' QRB will remain in the open position, until the user manually closes the device. A 'non-parking' QRB will always automatically default to a closed position.

Lid Types

We offer a choice of machined or forged lids. Forged lids are available with short or long handles to suit FIA or SFI requirements.

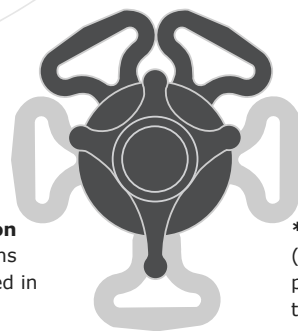

***'Right' Position**
(this tang remains permanently fixed in the device)

***'Left' Position**
(this tang remains permanently fixed in the device)

***'Crutch' Position**
(this tang remains permanently fixed in the device)

***Please note:** 'left' and 'right' positions are from the perspective of the user, when sat inside the harness (rather than looking at the device face on).



Specialist Models: We also manufacture a Stainless Steel QRB. This QRB is ideal for use in off-shore & Helicopter SAR use. (Please contact us for further information).

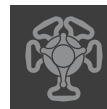

QR171



Full Lug Lid (FIA) QRB
Streamline, Lost Motion Mechanism
(Parking)

QR173



Half Lug Lid (SFI) QRB
Streamline, Lost Motion Mechanism
(Parking)

QR153



Machined Lid QRB
Standard, Rotary Mechanism
(Parking)

QR174



QRB
Streamline, Lost Motion Mechanism
(Non-Parking)

Tangs

ISC Tangs are stamped and have ergonomic, rounded edges. Standard Tangs are available in flat, or 20° cranked versions. Standard Tangs are available with a Silver or Black Finish.

AP153 Moustache Tang



AP154A Cranked



AP154C Cranked



AP150A Flat



AP150B Flat



Terms & Conditions

ISC Terms & Conditions of Sale

ISC reserves the right to change our Terms & Conditions without prior notice. The most up to date version can be viewed on our website: www.iscwales.com

Conditions of sale shall apply to all orders given to and accepted by International Safety Components Ltd. In these conditions "the seller" means International Safety Components Ltd, "the buyer" means the person, firm or company purchasing the goods, "the goods" means the goods or materials which shall be the subject of the contract between the seller and the buyer.

1. Incorporation of Conditions of Sale

All goods are sold or agreed to be sold by the seller subject to these conditions of sale which override any other terms or conditions stipulated or referred to by the buyer, whether in the order or in any document issued by the buyer or in any negotiations, and so that these conditions of sale are the only terms or conditions upon which the seller sells or supplies the goods.

2. Payment

I) Where credit terms apply, payment is due within 30 days of the date of the seller's invoice to the buyer.

II) If any payments due to the seller are not made on the due date the seller reserves the right to suspend any or all the deliveries of goods ordered by the buyer and/or by notice in writing to the buyer to cancel the contract without being liable for the consequential loss.

III) The seller reserves the right to charge the buyer interest on any sum outstanding beyond the period of credit allowed at the rate of 2% per month or part of a month.

IV) Accounts are strictly net.

3. Credits

No allowances will be made at settlement unless previously acknowledged by the seller's official credit note.

4. Delivery

I) Stated delivery terms shall not be binding on the seller. The seller shall not in any event be liable for any cost or damage caused by any reason of any delay in delivery.

II) A goods delivery will be assumed to have been made unless proof of delivery is requested within 14 days of invoice date. The buyer shall be deemed to have examined the goods at the time of delivery.

5. Force Majeure

The seller shall not be liable in any way for loss or damage arising directly or indirectly through or in consequence of delivery of the goods being prevented or delayed by happenings or occurrences due to or by reason of mobilisation, hostilities, acts of the Queen's enemies or war (whether declared or not), government action, departmental instructions or act of god, riots, combination of workmen, lockouts, strikes or disturbances wherever taking place, shortage of labour, raw materials, fuel or power in consequence of non-delivery or any other cause, want of transport, accidents, fire, flood, blocking of or accidents to aeroplanes, shipping or railway lines, failure of ships to sail at advertised times, reduction or stoppage of output at the works where the goods are being manufactured or premises to which they are to be delivered through fire, flood, heat, frost, storm, tempest or intemperate weather, breakdown, accidents to machinery, late provision to the seller of any materials information or instructions pertinent to the fulfilment of the order for the goods by the seller, or any other causes or any circumstances whatsoever beyond the seller's control or any acts of the third parties whether criminal or otherwise, and in these circumstances the seller expressly reserves the right to cancel or suspend the whole or any part of any delivery.

6. Quantities

The seller may deliver against an order an excess or deficiency of up to 10% of weight or volume ordered. The quantity actually delivered will be stated in the invoice.

7. Warranty and Liability

I) The seller warrants that the goods are manufactured with all care and skill and where applicable comply with the standard specifications set out in the seller's published literature in relation to the goods current at the date hereof and made available to the buyer and that the goods are of merchantable quality.

II) The application, use and processing of the goods is the absolute responsibility of the buyer. Any technical and other advice, information and data provided by the seller, whether verbally, in writing or by way of trials or tests, is given without warranty as to the suitability of the goods for their intended purposes and applications.

III) The buyer shall be deemed to have examined the goods at the time of delivery and unless notice of any defect is given by

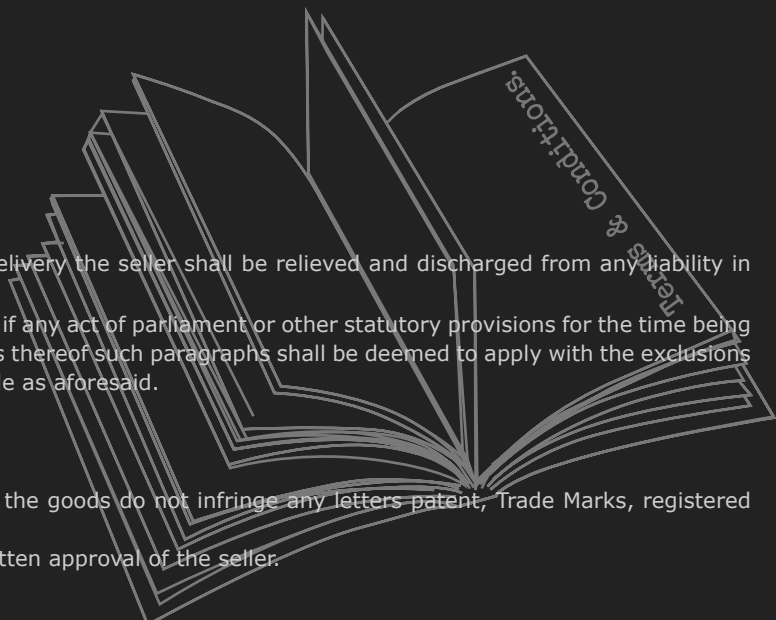

the buyer and received by the seller within 14 days after delivery the seller shall be relieved and discharged from any liability in respect thereof.

IV) The foregoing paragraphs inclusive shall apply save that if any act of parliament or other statutory provisions for the time being in force shall avoid or make enforceable any of the provisions thereof such paragraphs shall be deemed to apply with the exclusions of those provisions thereof which shall be void or enforceable as aforesaid.

8. Patents & Trade Marks

- I) No warranty or representation is given by the seller that the goods do not infringe any letters patent, Trade Marks, registered designs or other industrial rights.
- II) The use of the seller's Trade Marks requires the prior written approval of the seller.

9. Assignments

The contract of which these conditions form part is personal to the buyer who shall not assign the benefit thereof without the seller's written consent.

10. Proper Law

The construction, validity and performance of this contract shall be governed by the law of England.

11. Property and Risk

- I) Delivery of the goods shall be:
 - A) Where the seller undertakes delivery of the goods when they are loaded off the seller's vehicle, ship or other transport at the station port or address specified by the buyer,
 - B) Where the buyer undertakes to collect the goods, when they are loaded onto the buyer's vehicle or other transport at the address of the seller.
 - II) Passing of property:
 - B) If such payment is overdue in whole or in part the seller may (without prejudice to any of the seller's other rights) recover or resell the goods or any of them and may enter upon the buyer's premises for that purpose.
 - C) If any of the goods are incorporated in other goods before such payment the property in the goods delivered by the seller shall nevertheless be and remain with the seller until such payment has been made.
- The buyer agrees to store all such goods in such a way that they are readily identifiable as the property of the seller.
- E) Where any goods delivered under this contract have been sold by the buyer then the buyer shall so sell as agent for the seller and shall be trustee for the seller of the proceeds of sale thereof until such time as the seller shall have been paid in full for such goods.
 - F) Notwithstanding the provisions in sub-clause (A) hereof the sold goods shall be at the risk of the buyer from the time when they cease to be in possession of the seller and in particular when they are delivered into the possession or custody of a carrier, forwarding agent, Warehouseman or other Bailee or agent for the purpose of transmission whether such persons be in contract with or instructed by the seller or the buyer.

12. Default

If the buyer shall commit any breach of these conditions or if any distress or execution shall in the sole opinion of the seller, be unable to pay the seller for the goods or suspend payment of its debts or make any arrangements with its creditors, or being a company have a receiver appointed of its assets, or pass any resolution to be wound up, or being a person shall commit any act of bankruptcy, or have any bankruptcy petition presented against it, then in any such event the seller shall, without prejudice to any other rights and remedies it might have and without any liability whatsoever, be at liberty forthwith by notice in writing to the buyer:

To cancel all orders and contracts or any part thereof remaining unfulfilled between the seller and the buyer for the delivery of the goods;

Either for its agents or itself to have access to the buyer's premises for the protection, removal, realisation and disposal of any goods at any time and from time to time in which the property shall not have passed from the seller to the buyer in accordance with these conditions of sale.

13. Prices

All goods will be charged at the price ruling at the date of delivery, irrespective of any quotation given prior to that date, or of any price charged for similar goods previously delivered.

Prices quoted or charged exclude packing and delivery. All packages marked 'returnable' remain the property of the seller and should be returned as soon as possible after being emptied. Such packages may not be loaned, given or sold to any third party. ISC reserves the right to change the specification of any of the products featured, without prior notice.

climb. work. rescue.

I|S|C

Solutions in Metal

International Safety Components Ltd.
Unit 1, Plot 2
Llandygai Industrial Estate
Bangor
Gwynedd
LL57 4YH
United Kingdom

T > +44 (0) 1248 363 125
F > +44 (0) 1248 363 118

sales@iscwales.com
www.iscwales.com



Stay up to date with ISC e-mail Alerts!

Scan the QR Code with your Smartphone to register for ISC e-mail Alerts. We will email you from time to time with news of new products, product updates and other news features which are relevant to your chosen industry.

